

Installation Manual



CONTENTS

| | Page |
|---|-------------|
| 1. System Overview | 2 |
| 1.1 Roundshot Livecam | 2 |
| 2. Preparation prior to camera shipment | 5 |
| 2.1 Site preparation | 5 |
| 2.1.1. Installation of camera mast | 6 |
| 2.1.2. Network connection – example DSL / wired | 9 |
| 2.1.3 Network connection – example mobile network (4G) | 10 |
| 2.1.4 Power connection – mains adaptor | 11 |
| 2.1.5 Lightning protection (optional) | 12 |
| 3. Camera installation | 14 |
| 3.1 Network connection with DSL / wired | 14 |
| 3.2 Network connection with wifi or mobile network (4G) | 19 |
| 3.3 Network connection trouble-shooting | 25 |
| 3.4 Firewall settings | 26 |
| 3.5 Network security | 26 |
| 4. Technical Data | 27 |
| 5. CE Conformity Declaration | 28 |

Impressum

1. System Overview

1.1 Roundshot Livecam

This manual describes the Roundshot Livecam **generation 3**. The system consists of the following elements:



- (A) Livecam panorama camera with optional video camera
- (B) Waterproof cover with glass window
- (C) Ethernet cable (standard length: 30m / 100 ft) with ferrite
- (D) Power cable (standard length: 30m / 100 ft) with mains adaptor and socket cable with ferrite
- (E) Tripod adaptor with distance ring (for demo mounting)

Livecam panorama camera with optional video camera: front and back view

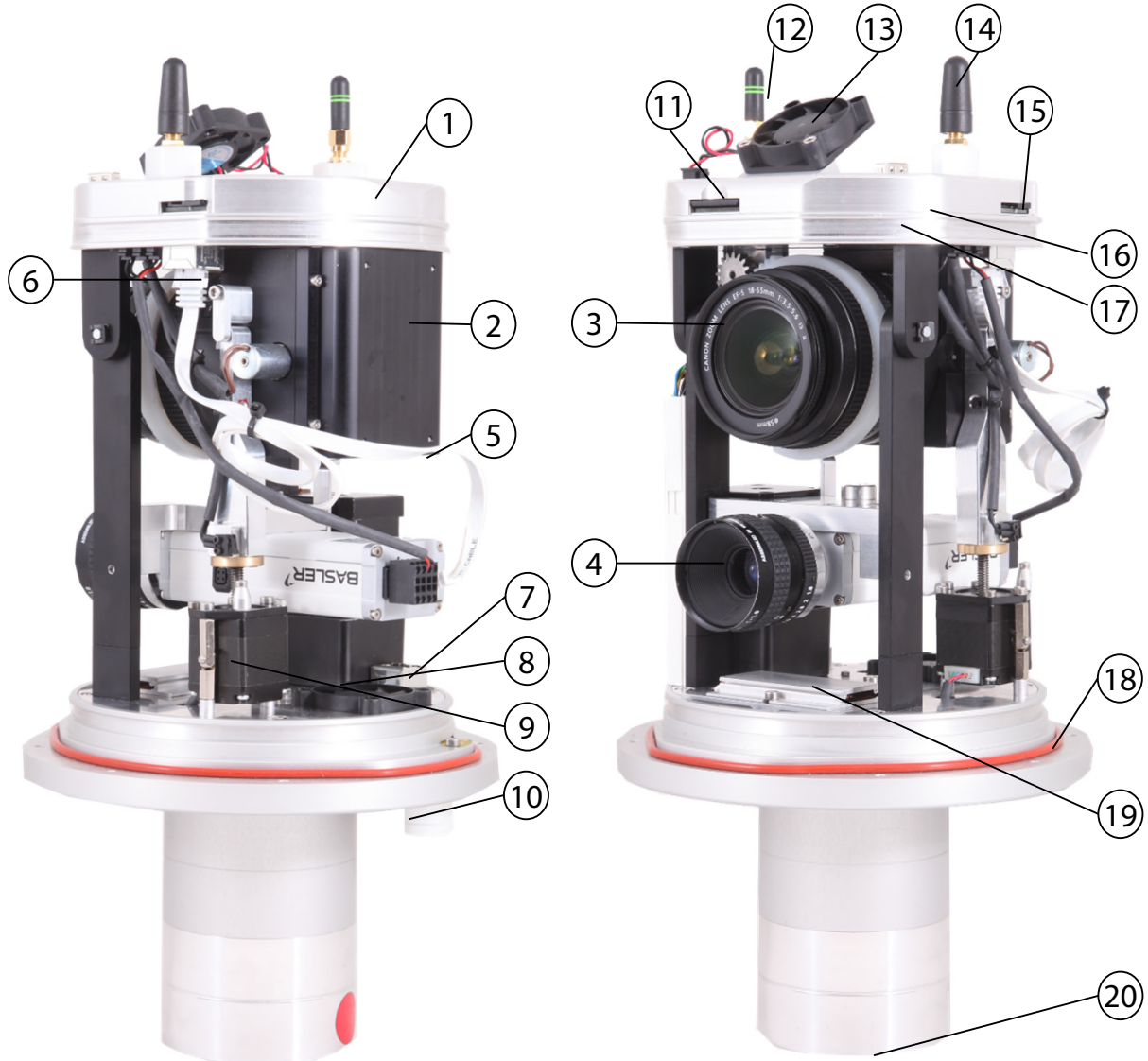

- | | |
|---|---|
| ① Computer with embedded Linux OS | ⑪ SD card for storage |
| ② RGB line scanner (panorama camera) | ⑫ Wifi module with antenna (optional) |
| ③ Lens with focal, focus, aperture + tilt control | ⑬ Upper fan |
| ④ Video camera with lens (optional) | ⑭ 4G antenna |
| ⑤ Video RJ45 connection cable | ⑮ 4G module with SIM card slot |
| ⑥ RJ45 computer socket for video connection | ⑯ Compass (optional) |
| ⑦ RJ45 exit socket for video streaming | ⑰ GPS (optional) for mobile installations |
| ⑧ Horizontal motor (for 360° rotation) | ⑱ Rubber seal |
| ⑨ Vertical motor (tilt) | ⑲ Heating element with thermostat + fan |
| ⑩ Integrated weather sensors | ⑳ Socket with 1x power + 2x RJ45 plugs |

Livecam panorama camera with optional video camera: top view

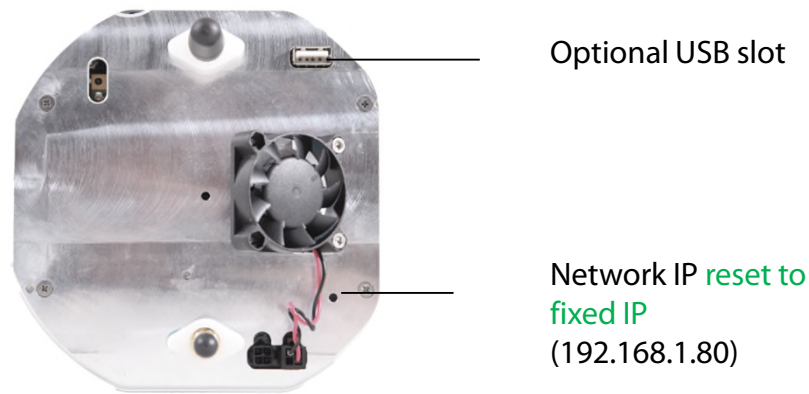

Livecam panorama camera with optional video camera: bottom view

The ferrite elements are installed on the cable strands close to the camera. Installing them on the opposite side of the cable is possible but will be less beneficial for the camera.

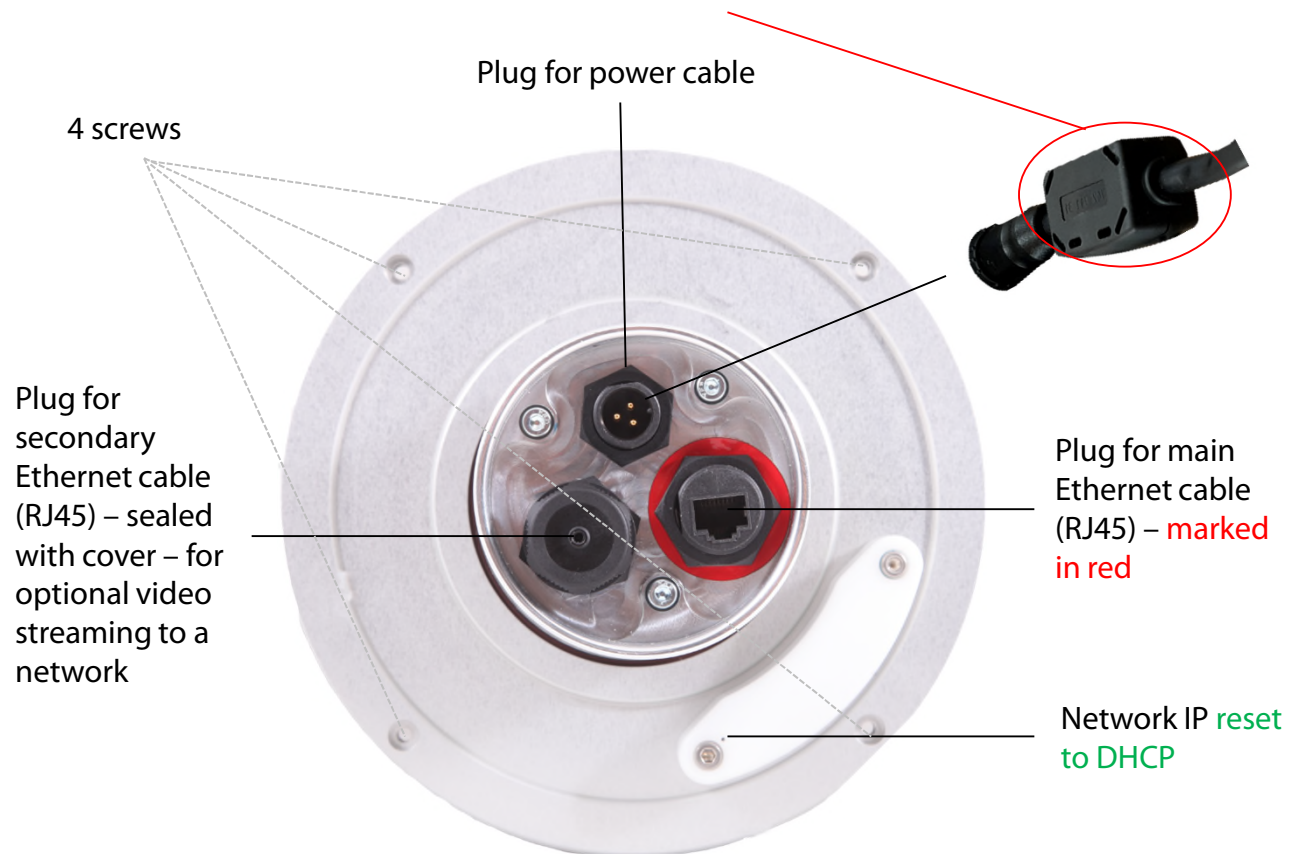

Ferrite beads are used in electronic circuits to suppress interference, noise, crosstalk, and other high-frequency disturbances from supply voltage lines, data signal lines, and ground planes.

2. Preparation prior to camera shipment

2.1 Site preparation

The customer is responsible for selecting the camera site and preparing for the installation of the camera. Proper site preparation includes:

- Selection of best **camera position** (ideally with 360° view)
- Installation of **camera mast**
- Selection of **connection type** (wired Ethernet, wifi or cellular 4G)
- Preparation of **network connection** requirements:
 - DHCP or fixed IP
 - Firewall settings as required
- Preparation of **power connection** 110V or 220V with protected location for mains adaptor (for example in waterproof box if installed outdoors)
- Installation of **power supply** and lightning/surge protection
- Installation of **power cable** - maximum length: 30m / 100 ft
- Installation of **Ethernet cable** (if wired) – maximum length: 100m (or longer if connecting through switch)



2.1.1. Installation of camera mast

Mast types

Wall attachment with straight tube

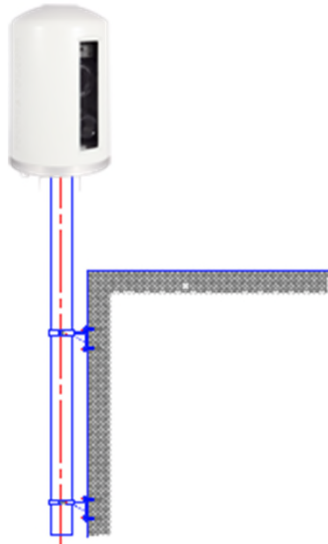

Wall attachment with curved tube

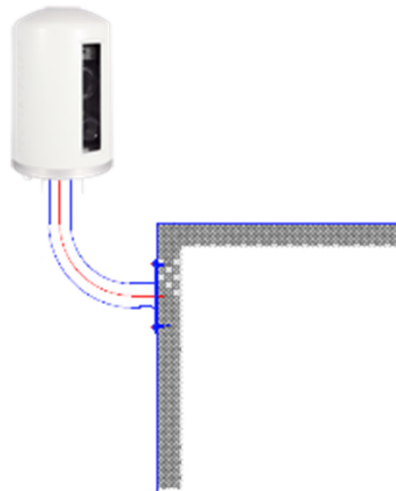

Stand-up tube for flat attachment on ground

Roof attachment (roof pass-through)

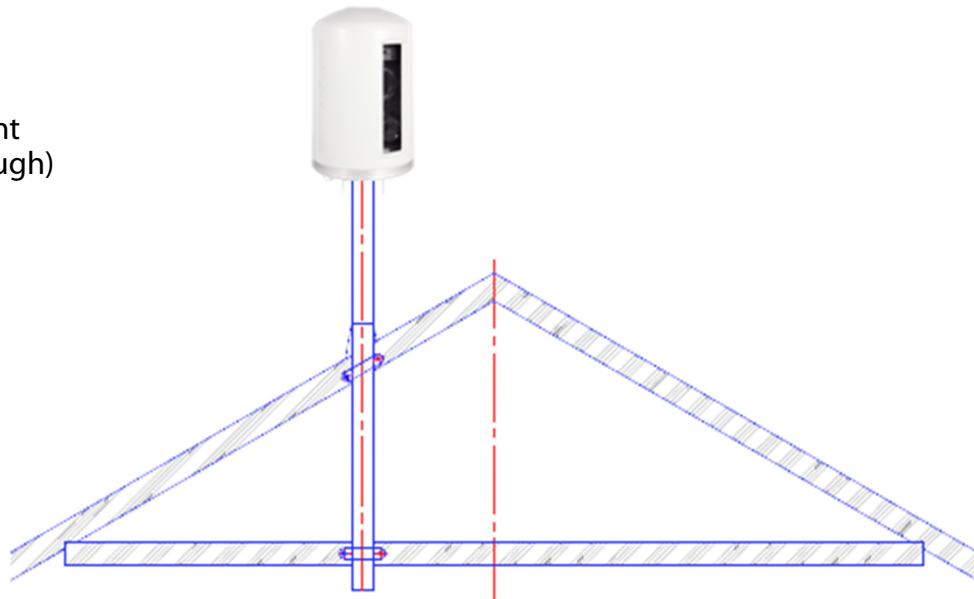

Very important: The mast must be connected by cable (yellow/green) to the ground.

2.1.1. Installation of camera mast

Camera dimensions

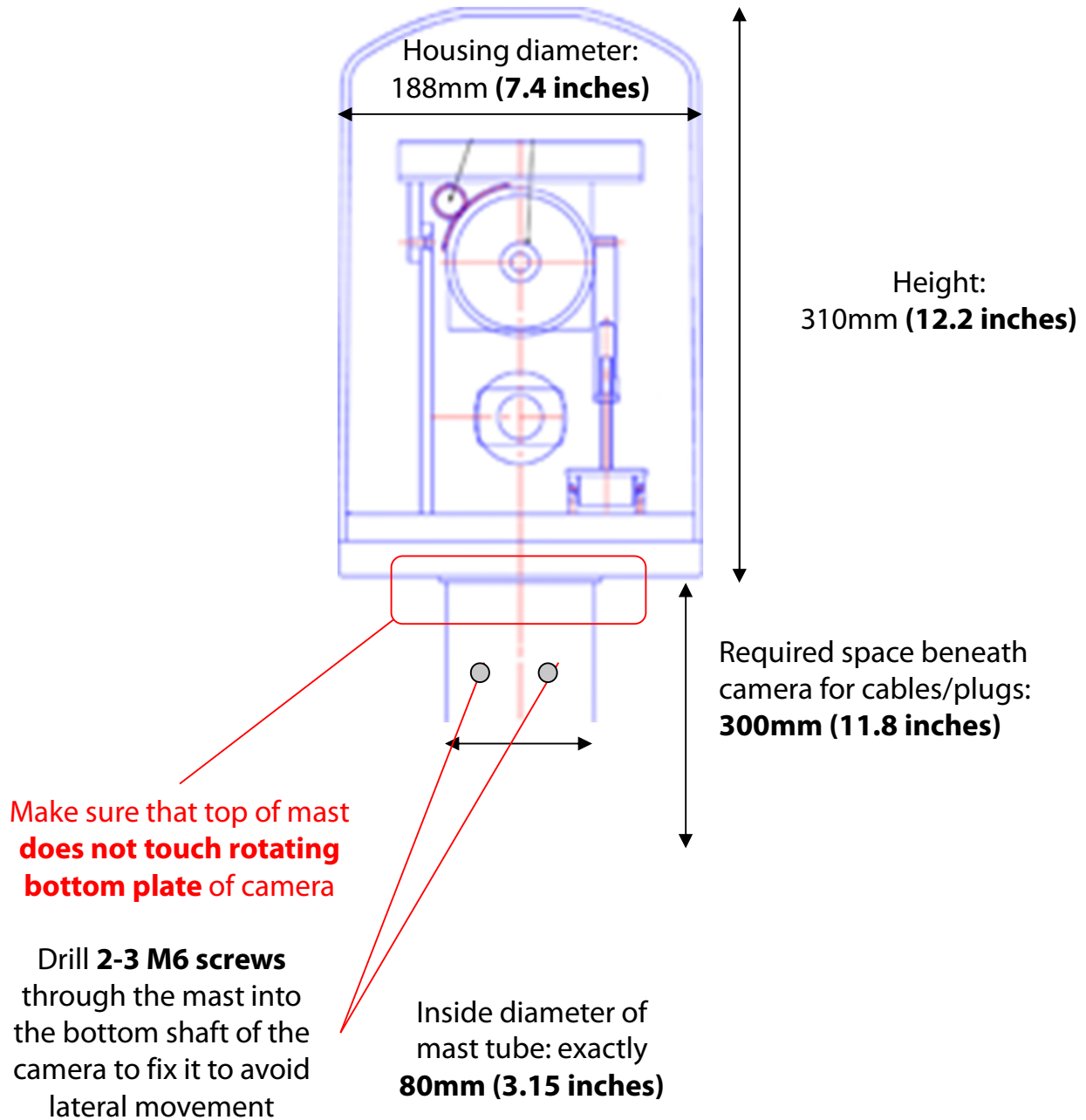

2.1.1. Installation of camera mast (continued)

Correct mounting

Incorrect mounting
(camera motor sits on mast
inner dimensions of mast > 80mm)

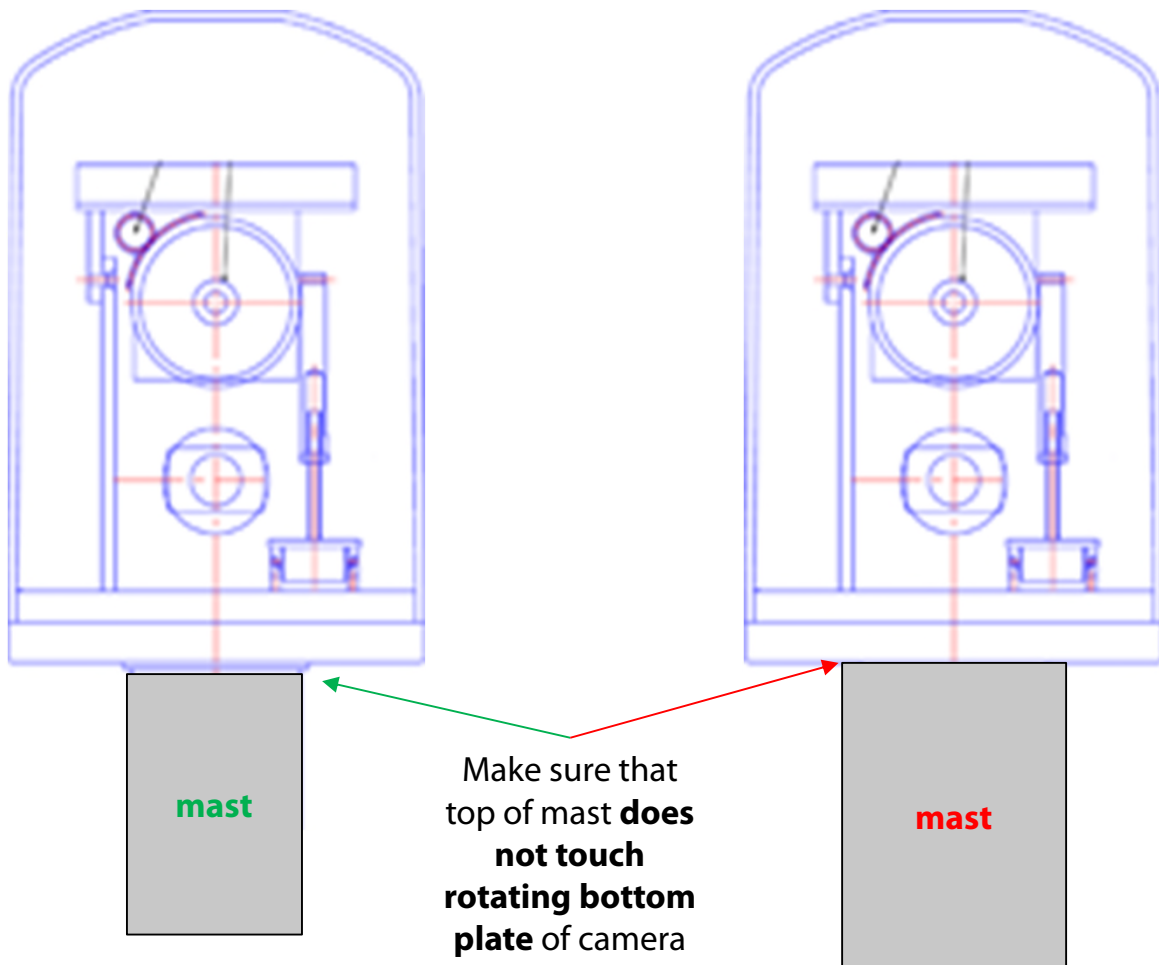

2.1.2. Network connection – example DSL / wired

Power cable

Pin 2 = +24V
Pin 3 = -



Mains adaptor
110-220V / 24V

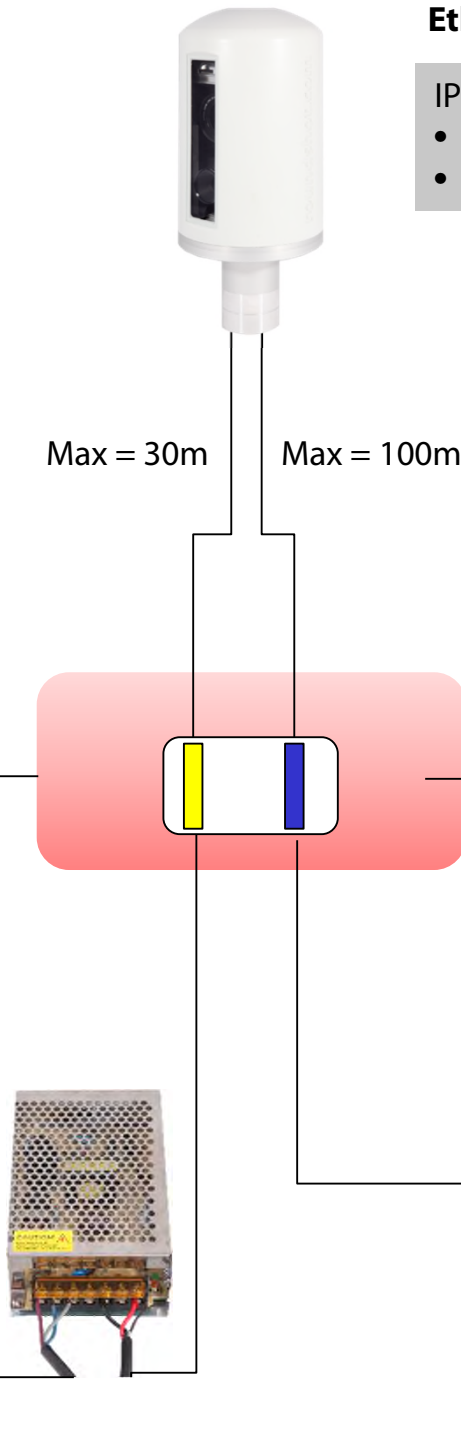

Ethernet cable (RJ45)

IP:

- DHCP or
- Fixed



- Please provide the following network data to Roundshot prior to shipping:
 - IP through DHCP (automatically assigned by switch/router/network)
 - IP fixed
- If fixed, please provide: IP, subnet mask + gateway

2.1.3. Network connection – example mobile network (4G)

Power cable

Pin 2 = +24V
Pin 3 = -



Mains adaptor
110-220V / 24V



Max = 30m



mobile network (4G)

IP:

- Fixed to standard
192.168.1.80

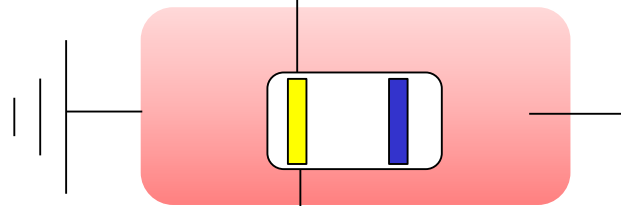

Lighting protection
Power (optional)



Internet access
→
Router / DSL



- Please confirm to Roundshot prior to shipping that the camera will be connected through wifi or through 4G.
- The camera will be shipped with a standard fixed IP (192.168.1.80) for direct connection and configuration (connection to wifi, connection to mobile network)

2.1.4. Power connection – mains adaptor



Connectors on mains adaptor:

- 1 = L
- 2 = N
- 3 = ground
- 4
- 5 = minus
- 6
- 7 = plus
ground



Very important: The mains adaptor casing must be connected by cable (yellow/green) to the ground.

2.1.5. Lightning protection (optional)

- The optional lightning protection is installed closely beneath the camera on the mast.
- It protects the camera from being damaged by lightning (overcharge) induced by the cables into the camera housing.
- Two sets of cables are provided:
 - Short cables from camera to lightning protection box
 - Long cables from lightning protection box to mains and switch/internet
- Two openings of about 5cm diameter (2 inches) each need to be drilled into the mast to pass the cables to the lightning protection box from inside the mast tube

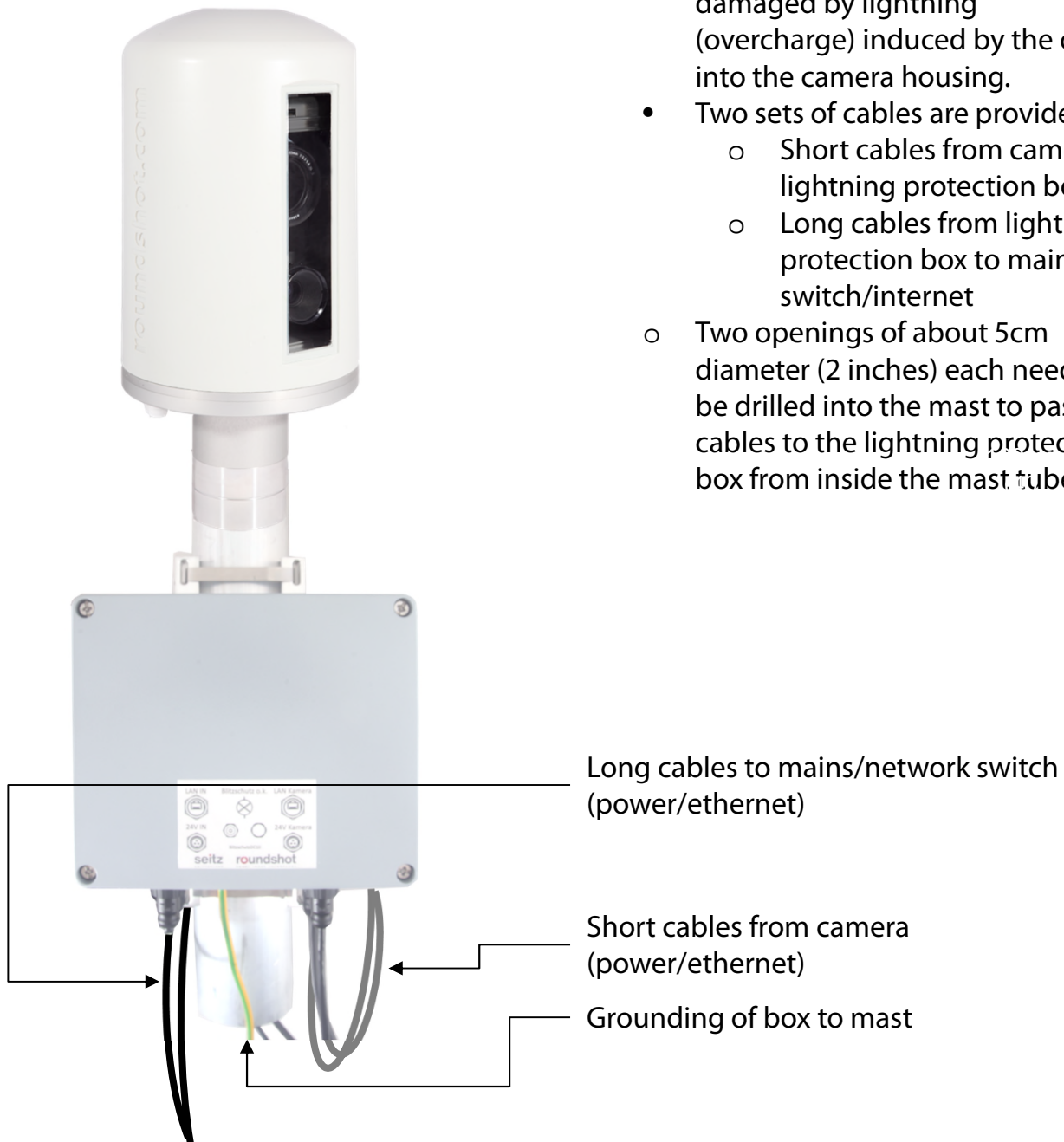

Very important: The lightning protection box and the mast must be connected by cable (yellow/green) to the ground.

2.1.5. Lightning protection (optional) – (continued)

Box open:

Grounding cable to cover

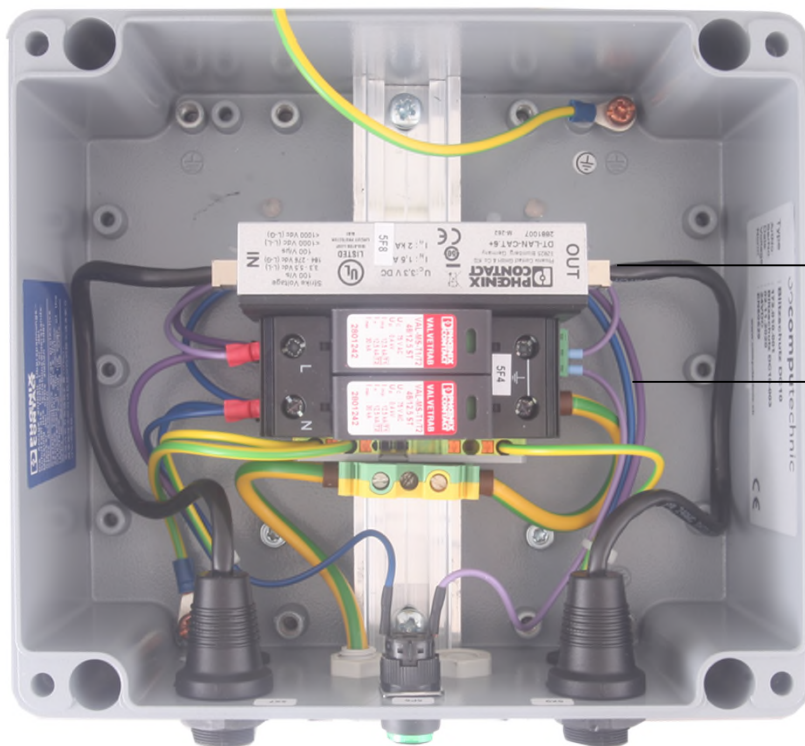

Surge protection RJ45

Surge protection power L + N)

Box from below:

Control LED power «OK»

RJ45-cable long (to DSL router/switch)

Power cable long (to mains)

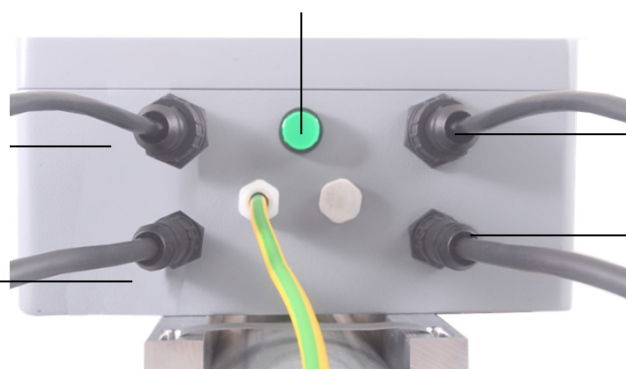

RJ45 short (to camera)

Power cable short (to camera)

Grounding cable to mast



When installing the lightning protection the box does not have to be opened. Attach the box to the mast and connect the cables.



Very important: The mast has to be grounded.

3. Camera installation

3.1 Network connection with DSL / wired

Please **test the network connection in the office before installing** the Livecam on the mast. This avoids lengthy installations/deinstallations.

Before shipping the Roundshot team will prepare the network card of the Livecam computer according to customer instructions:

- **DHCP** (to assign automatically by switch/router/network (standard case for private or small networks)
- **Fixed IP** (for larger networks where IPs are assigned by network administrator)

In this case the Livecam should connect to internet automatically once installed.

Please allow 5-10 minutes for the camera to power up, calibrate itself and obtain the IP or register in the network. Once the internet connection is established, the Livecam will automatically log in at the Roundshot VPN server and the Roundshot staff can connect to the camera.

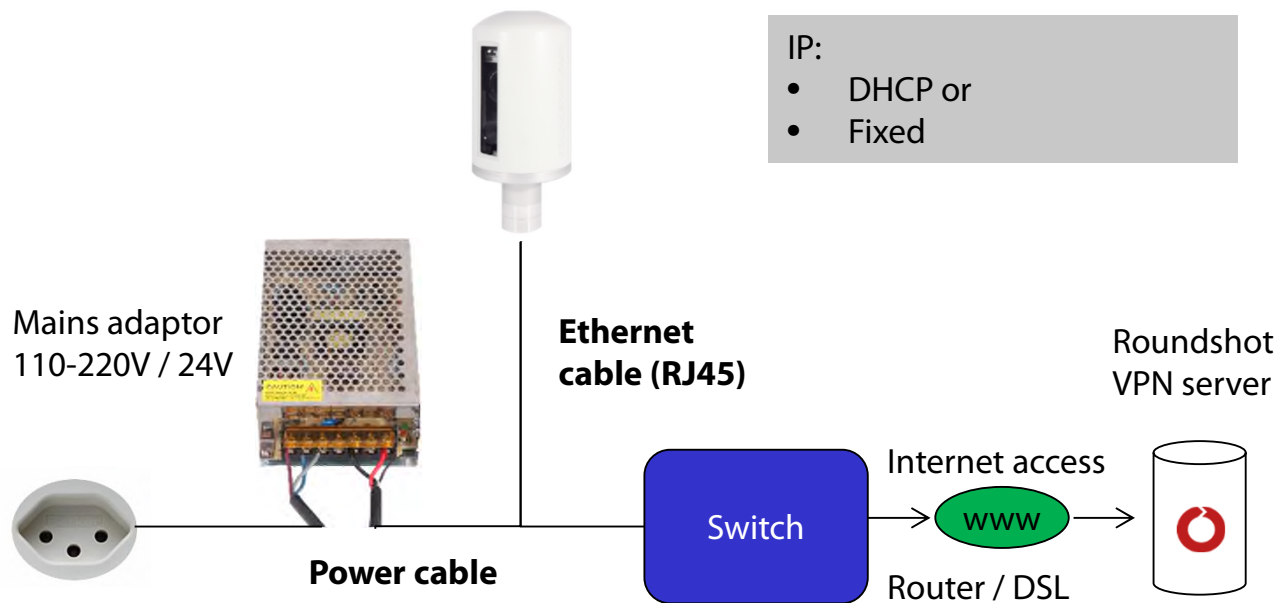

Contact the Roundshot team who will check if the connection to the VPN (remote access to camera) has been successfully established.



If yes, we will now connect to the camera to configure it for service.

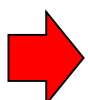

If no, please go to section «problem solving» to establish the connection.

3.1 Network connection with DSL / wired (continued)

To connect to the Livecam, the first step is to **determine the IP that is currently used by the camera computer**.

- If the Livecam will use a **fixed IP**, this fixed IP has already been sent to roundshot and set in the network configuration of the computer, so you will be able to use that IP.
- If the Livecam is obtaining its **IP automatically** through **DHCP**, there are two ways to obtain its IP:
 - a. By having the camera powered up and connected by RJ45 cable within the network and using an IP scanner software (such as Angry IP Scanner: <https://angryip.org/download>)
 - b. By resetting the camera computer to a fixed IP (192.168.1.80) using a hardware reset button -> see chapter 3.3 Network connection trouble-shooting
- If all of the above fails, it is also possible to use the **Livecam serial number** to connect: **roundshot_#####** where the last 6 digits represent the last 6 digits of the computer mac address. This serial number can be found:
 - on the camera front panel (above lens)
 - on the Livecam invoice
 - by scanning the network for new IPs / mac addresses
 - by contacting roundshot

Bring your **computer network configuration** into the same range as follows – for example:

computer IP: 192.168.1.70
subnet mask: 255.255.255.0
gateway 192.168.1.1

camera: 192.168.1.80

Download VNC Viewer (RealVNC, not Ultra VNC) and connect to the camera computer:

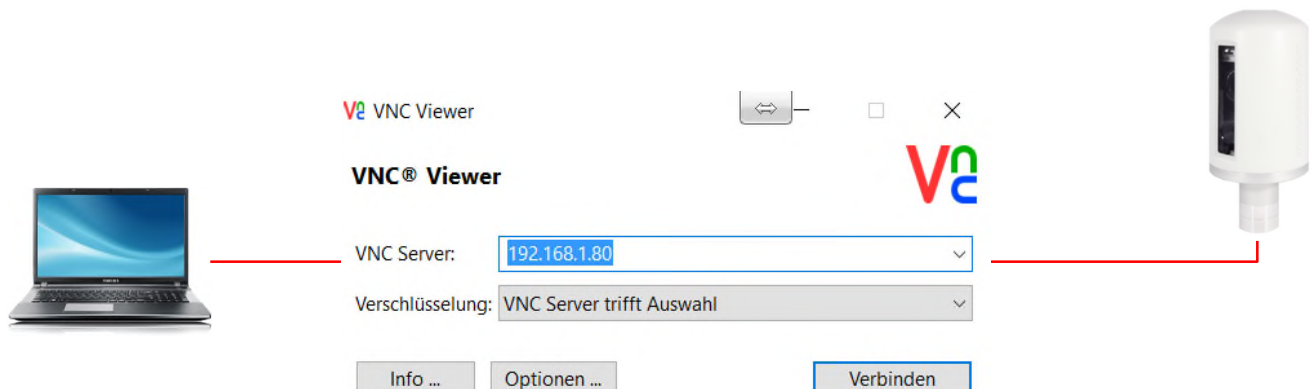

3.1 Network connection with DSL / wired (continued)

User: livecam

Only the **password** needs to be entered.

Password: **livecamG3**



Factory **default password** (without upload password)

Password: *****



Equal to **upload password** if the upload credentials have already been prepared prior to shipping

This opens a connection to the Livecam computer with Linux operating system:

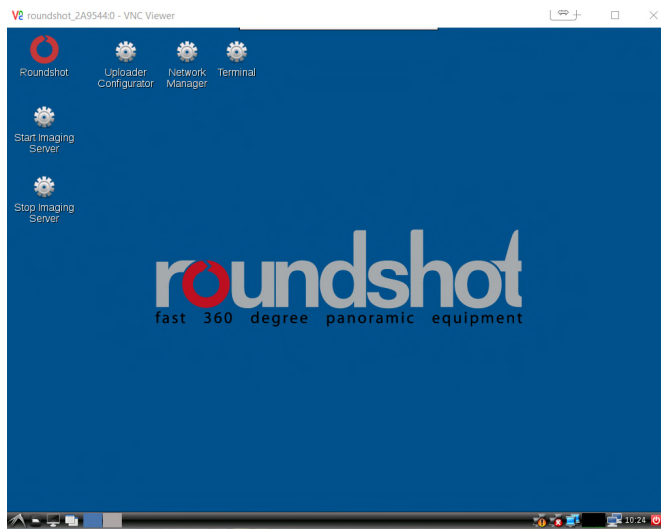

An alternate method is to connect by using the computer mac address / serial number of the camera (roundshot_#####):

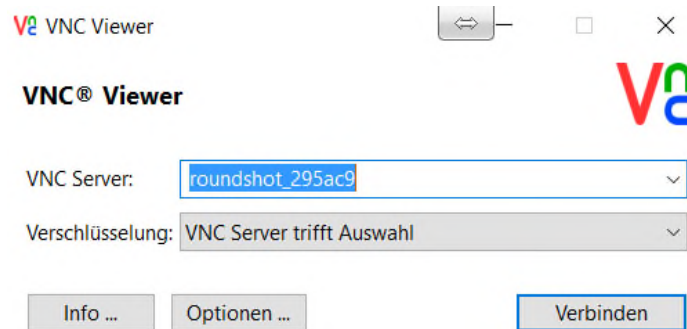

Once the Uploader is activated with an **upload password**, it will automatically be set as **access password** to the camera.



If the upload configuration of the Livecam has already been prepared by roundshot prior to shipping, please contact roundshot to obtain this password.

3.1 Network connection with DSL / wired (continued)

Now open up the **network configuration menu** with a right-mouse click on the two computers next to the clock:

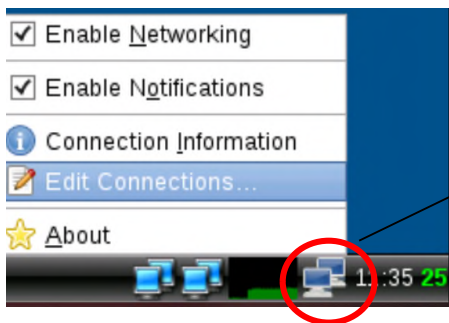
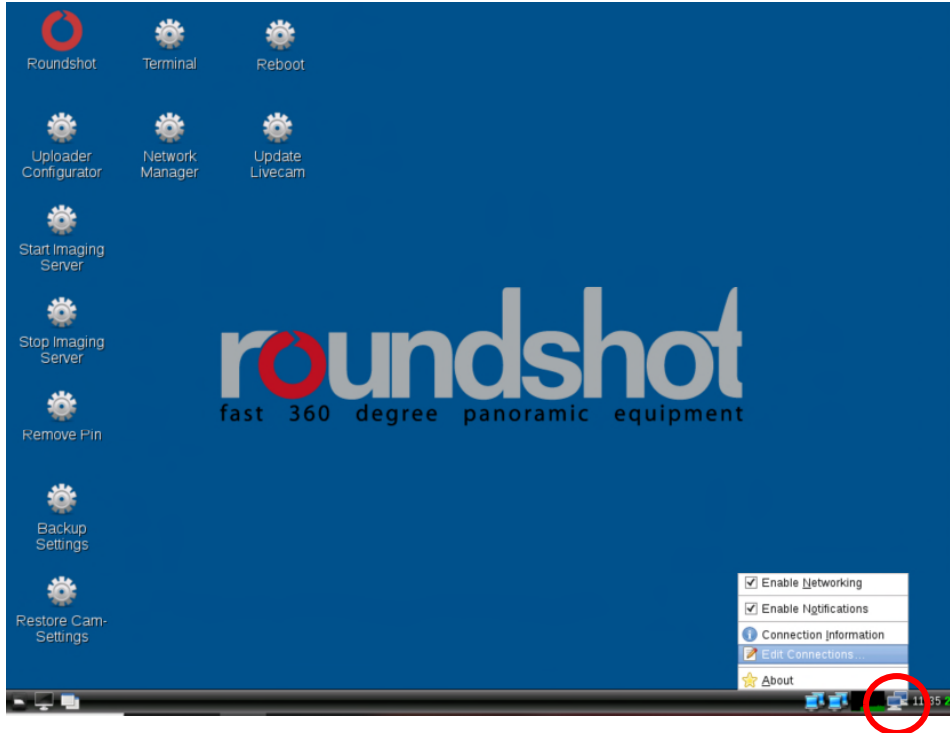

right mouse-click

Click on first ethernet connection + Edit

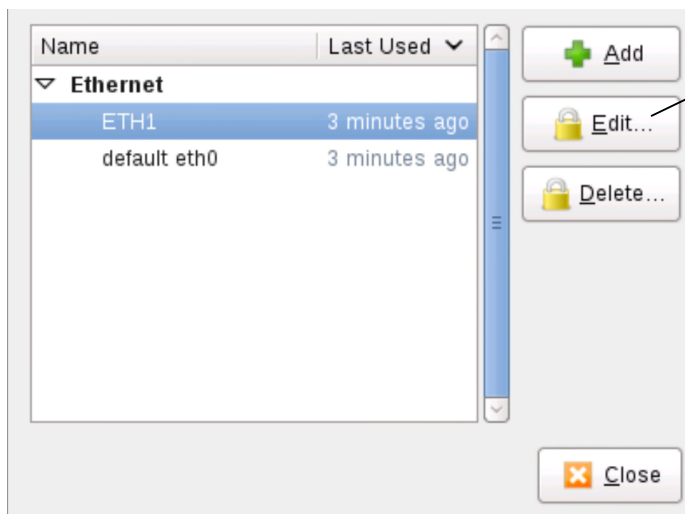

3.1 Network connection with DSL / wired (continued)

Click on the IPv4 Settings tab and select the preferred **method**:

- Manual (fixed IP)
- DHCP (automatic IP)

When choosing “Manual” please enter the **complete network parameters** including IP (address), subnet mask (Netmask), gateway + DNS + Search Domains, for example:

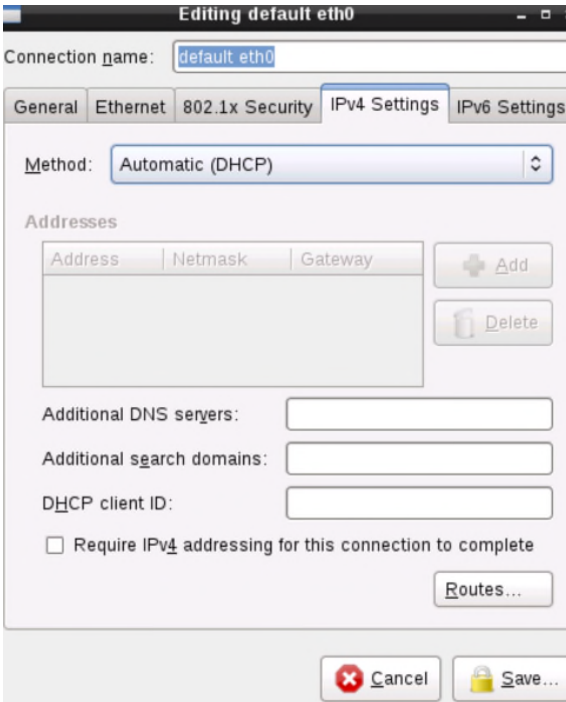

Press **“Save”** and **“Close”** to return to the desktop.

3.2 Network connection with GSM network (4G)

Please **test the network connection in the office before installing** the Livecam on the mast. This avoids lengthy installations/deinstallations.

For Livecams that connect to the network by wifi or by mobile network a **special module** needs to be installed in the camera computer. Please make sure to specify this requirement when ordering the camera.

In this case, the Roundshot team will set a fixed IP for the camera computer:

- 192.168.1.80

It is not possible to pre-configure the mobile network access without any connection. This needs to be established on site.

Connect a laptop or other computer directly to the camera:

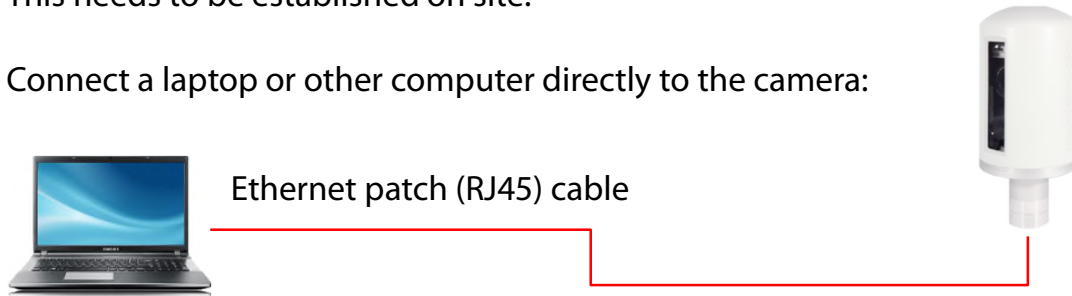

Set the IP of your computer (ethernet card) within the same range and subnet as the camera, for example:

IP-Adresse automatisch beziehen

Folgende IP-Adresse verwenden:

IP-Adresse:

Subnetzmaske:

Standardgateway:

DNS-Serveradresse automatisch beziehen

Folgende DNS-Serveradressen verwenden:

Bevorzugter DNS-Server:

Alternativer DNS-Server:

3.2 Network connection with GSM network (4G) – (continued)

Download and install a **VNC software** to establish the connection, for example VNC Viewer. Enter the fixed IP of the camera to connect:

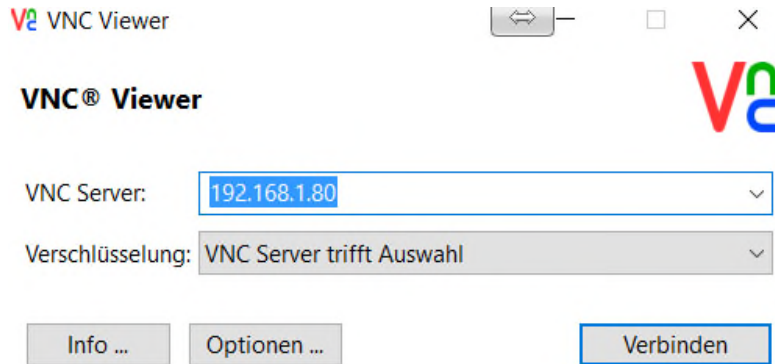

User: livecam

Only the **password** needs to be entered.

Password: **livecamG3**



Factory **default password** (without upload password)

Password: *****



Equal to **upload password** if the Livecam has already been prepared with upload credentials prior to shipping

This opens a connection to the Livecam computer with Linux operating system:



Once the Uploader is activated with an **upload password**, it will automatically be set as **access password** to the camera.



If the upload configuration of the Livecam has already been prepared by roundshot prior to shipping, please contact roundshot to obtain this password.

3.2 Network connection with mobile network (4G) – (continued)



Insert a large mobile network mini-SIM card into the slot of the camera computer.

Make a **right mouse-click** on the icon with the double screen to display the menu for enabling or disabling network connections.

Enable the Mobile Broadband connection by ticking the box.

Wait a few seconds – the activation of Mobile Broadband is indicated by a rotating green/blue icon.

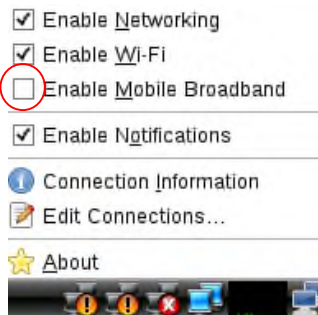

Again using a right mouse-click on the icon with the double screen click on **edit connections**.

Click on the button «**Add**».

Choose a Connection Type: **Mobile Broadband** + confirm with «**create**».

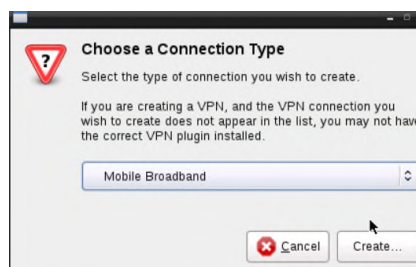
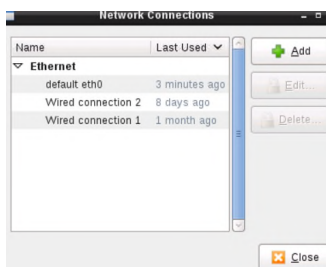
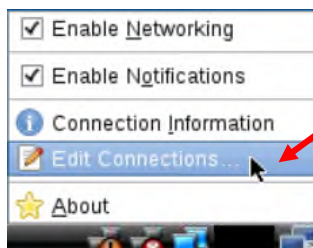

3.2 Network connection with mobile network (4G) – (continued)

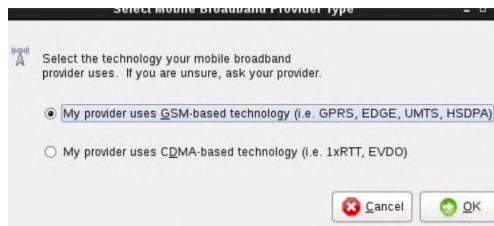

Choose «**My provider uses GSM-based technology**» and confirm with «**OK**».

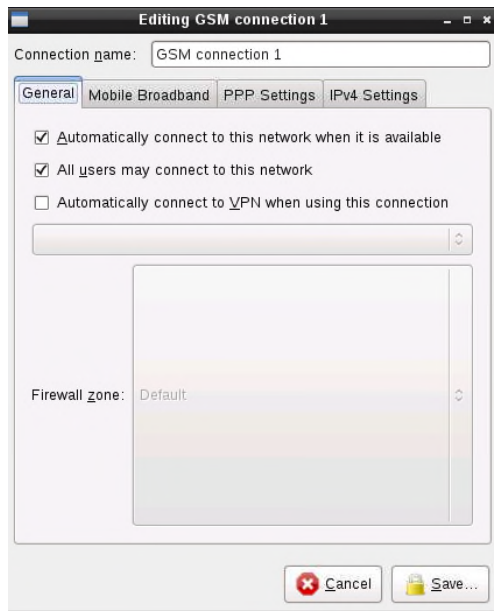

Tick the box next to

- «**Automatically connect to this network when it is available**» and
- «**All users may connect to this network**».

3.2 Network connection with mobile network (4G) – (continued)

Edit now the settings for this GSM Connection and enter the data according to the following table:

- Number
- Username
- Password
- APN
- Network ID

| Provider | Country | Number | User name | Password | APN | Network ID |
|----------------------------|-------------|--------|-----------|----------|------------------|------------|
| Swisscom | Switzerland | *99# | | | gprs.swisscom.ch | 22801 |
| Sunrise | Switzerland | *99# | | | internet | 22802 |
| Salt (Orange) | Switzerland | *99# | | | internet | 22803 |
| Digital Republic (Sunrise) | Switzerland | *99# | | | dr.m2m.ch | 22802 |
| Orange | France | *99# | orange | orange | orange.fr | 20801 |
| SFR | France | *99# | | | wapsfr / s12sfr | 20810 |
| TIM | Italy | *99# | | | ibox.tim.it | 22201 |

Enter the **Network ID** of your provider to always lock the connection. This prevents potential roaming.

Untick «Allow roaming» to fix the connection to your provider.

PIN: The PIN code needs to be deactivated on the SIM card (for example by using the SIM in a mobile phone)

Confirm all settings by pressing **«save»**.



The APN settings of your GSM provider can be found by a google search, for example "APN settings orange france".

3.2 Network connection with mobile network (4G) – (continued)

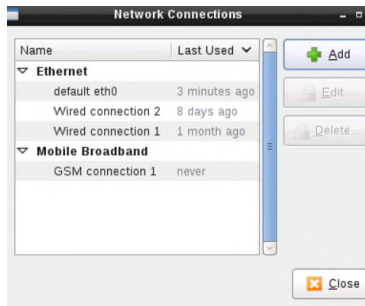

The new GSM connection 1 is now displayed in the list of network connections.

Click on «**close**».

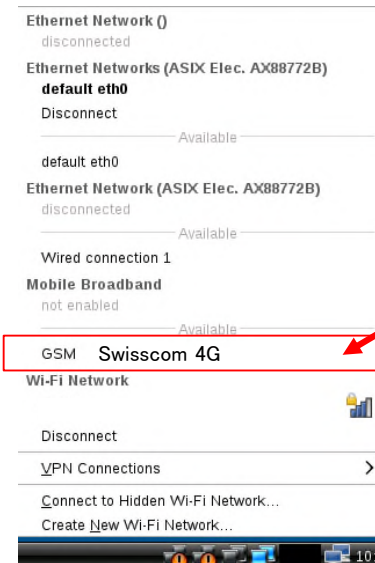

Make a **left mouse-click** on the icon with the double screen to display all available network connections.

The available GSM mobile network is now displayed.

The camera is now connected to your GSM network. Unplug your ethernet cable.

After a reboot the camera will connect to the GSM network within 5-10 minutes.

Contact the Roundshot team who will check if the connection to the VPN (remote access to camera) has been successfully established.



If yes, go ahead with the installation of the camera on the mast. Once the camera is installed, the Roundshot team will now connect to the camera to configure it for service.



If no, please go to section «trouble-shooting» to establish the connection.

3.3 Network connection trouble-shooting

If the connection cannot be established please follow these steps:

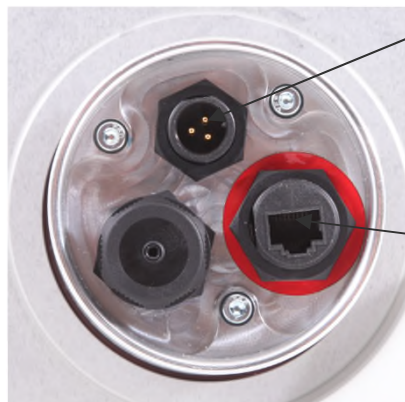

1. Is the power cable with mains adaptor plugged-in and is the camera powered-up? If so, the fans turn which creates a distinctive noise (even with closed waterproof case).
2. Is the ethernet (RJ45) cable plugged into the correct socket on the camera? This socket is marked in red. The alternative socket is for video streaming and cannot be used for camera connections.
3. Do you know the IP of your camera? The standard (factory) IP is 192.168.1.80.
4. Have you set **the correct IP** on your computer? The computer IP needs to be different from the camera IP but in the same range, for example:

camera: 192.168.1.80

computer IP: 192.168.1.70

subnet mask: 255.255.255.0

gateway: 192.168.1.1

5. If all fails, please **reset the camera IP** either to a fixed (factory) IP or to DHCP (automatic IP from network). Use a small PIN and **press 10 seconds in the reset slot** on top (computer) or bottom of camera:

view from top:



Network IP
reset to fixed IP
(192.168.1.80)

view from bottom:



Network IP reset
to DHCP

Wait approximately 5 minutes for the camera to reinitialise. It may be necessary to repeat this procedure.

3.4 Firewall settings

The following ports need to be opened on the firewall to allow communication between Livecam and external servers:

| Port | Remarks |
|------|---|
| 80 | VPN connections – binary packets may not be blocked |
| 443 | Uploader (https) |
| 123 | Time synchronisation with time servers |

3.5 Network security

For security reasons the Linux computer does not contain any DNS server. All internet connections are established between camera and a set of predefined IPs + URLs:

- backend.roundshot.com
- endpoint.roundshot.com
- vpn.roundshot.com
- ntp.metas.ch
- time.c.nist.gov
- time.nrc.ca
- ntp.nml.cairo.au
- time.stdtime.gov.tw

4. Technical Data



| Roundshot Livecam | |
|----------------------------------|---|
| Sensor type | 3-linear RGB sensor |
| Vertical resolution | 2,048 pixels |
| Dynamic range | 9 f-stops |
| Lens brand | Canon |
| Focal length | from 18mm to 55mm - longer focals on request |
| Horizontal resolution | for example with 72mm lens: 32,313 pixels |
| Total resolution | 2,048 x 32,313 pixels = 66 million pixels |
| File type | jpg |
| Min. time for a 360° scan | with 24mm lens: 6 seconds |
| Exposure times | from 1/333 sec. to 10 seconds (per pixel) |
| Exposure options | automatic with prescan, automatic with variation, prescan with variation, manual |
| Sensitivity control | ISO/ASA 100, 200, 300, 400, 600, 800 |
| Image format | adjustable vertically and horizontally: automatic/remote control of focal, focus, f-stop + vertical tilt |
| Image angle | from 1° to 360° in 1° steps |
| Housing* | dimensions: height: 310mm (12.2 inches), diameter: 188mm (7.4 inches) weight: 5.0 kg |
| Camera control | with integrated mini-computer running Linux OS |
| Image saving | on SD card (standard size: 32 GB, larger capacities available) |
| Web connectivity | DSL (ethernet/RJ45) via router/switch, optional wifi, 3G/4G cellular network (optional) |
| External power supply | 110-220V, 24V mains adaptor |
| Hardware | high resolution 360° camera in weatherproof case, connection cable ethernet (any length) and power (max. 30m), mains adaptor (power), professional Canon zoom lens 18-55mm, optional video camera |
| Software | Roundshot Livecam capture software, Roundshot Image Uploader, Roundshot web service (data plan) including webhosting, html5/html4 website, smartphone + tablet apps, screensaver software, partner websites, weather module, remote maintenance |
| Additional accessories | See price list |

Technical changes reserved.

5. CE Conformity Declaration

Lustdorf, 30 July 2016



CE Conformity Declaration

We declare under our own responsibility that our product

Livecam Generation 3

is compliant with the main requirements of machinery directive 2006/42/EG.

The following standards have been applied:

EN 55022 : 2010 / AC:2011

EN 55024 : 2010

EN/IEC 61000-3-2: 2014

EN/IEC 61000-3-3: 2013

Date and location:

Lustdorf / Switzerland, 30 July 2016

Seitz Phototechnik AG



Werner Seitz



Urs Krebs

Attachment:

EMC Testcenter AG test report

Impressum



Copyright 2024 by

Seitz Phototechnik AG
Frauenfelderstrasse 26
8512 Lustdorf / Switzerland

ph: +41 52 369 68 00
email: info@roundshot.com

www.roundshot.com

Technical changes reserved
April 2024

