

# Installation manual



# CONTENTS

Page

<b>1. System Overview</b>	<b>2</b>
1.1 Roundshot Livecam components	2
1.2 Livecam SD card + optional GSM card	3
1.3 Livecam DSL and GSM versions – fixed or automatic IP (DHCP)	4
<b>2. Preparation prior to camera shipment</b>	<b>5</b>
2.1 Site preparation	5
2.1.1. Installation of camera mast	6
2.1.2. Network connection – example DSL / wired	11
2.1.3. Network connection – example mobile network (4G)	12
2.1.4 Power connection – mains adaptor	13
2.1.5 Attaching the mains adaptor with metallic box on a mast	14
2.1.6 Lightning protection (optional)	17
<b>3. Camera installation</b>	<b>19</b>
3.1 Network connection with DSL / wired	19
3.2 Network connection with GSM network (4G)	24
3.3 Network connection trouble-shooting	30
3.4 Firewall settings	31
3.5 Network security	31
<b>4. CE Conformity Declaration</b>	<b>32</b>

## Impressum

# 1. System Overview

## 1.1 Roundshot Livecam components

This manual describes the Roundshot Livecam **generation 4**.

The system consists of the following elements:



- (A) Livecam using DSL connection (without GSM module/antenna)
- (B) Mains adaptor (Meanwell UHP-500 500W 24V) on waterproof aluminium box (optional)
- (C) Power supply cable 1m 220V (can also be supplied with EU or US power connector)
- (D) Ethernet cable shielded, standard 15m / 50ft or 30m / 100 ft (up to 100m possible)
- (E) Power cable maximum 15m (50ft)

## 1.2 Livecam SD card + optional GSM card



### Livecam generation 4 using GSM connection (4G) with GSM router + antenna

GSM card + SD card slot cover

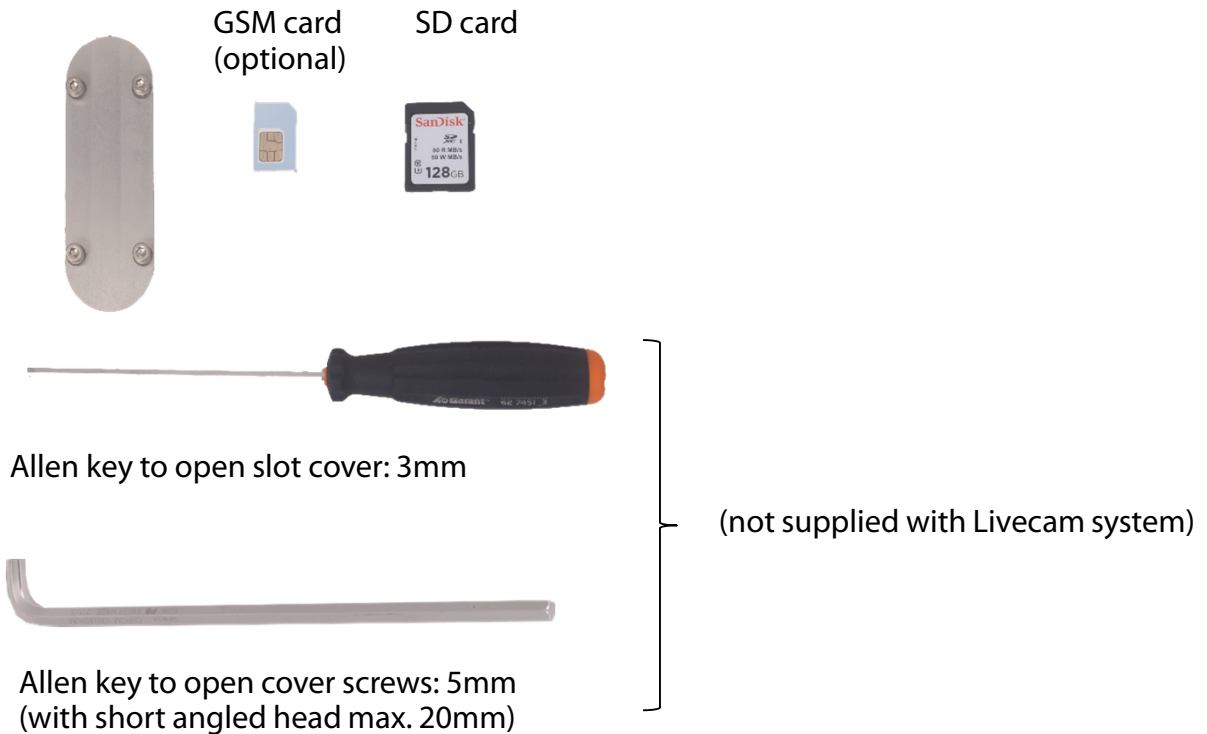

### 1.3 Livecam DSL and GSM versions – fixed or automatic IP (DHCP)

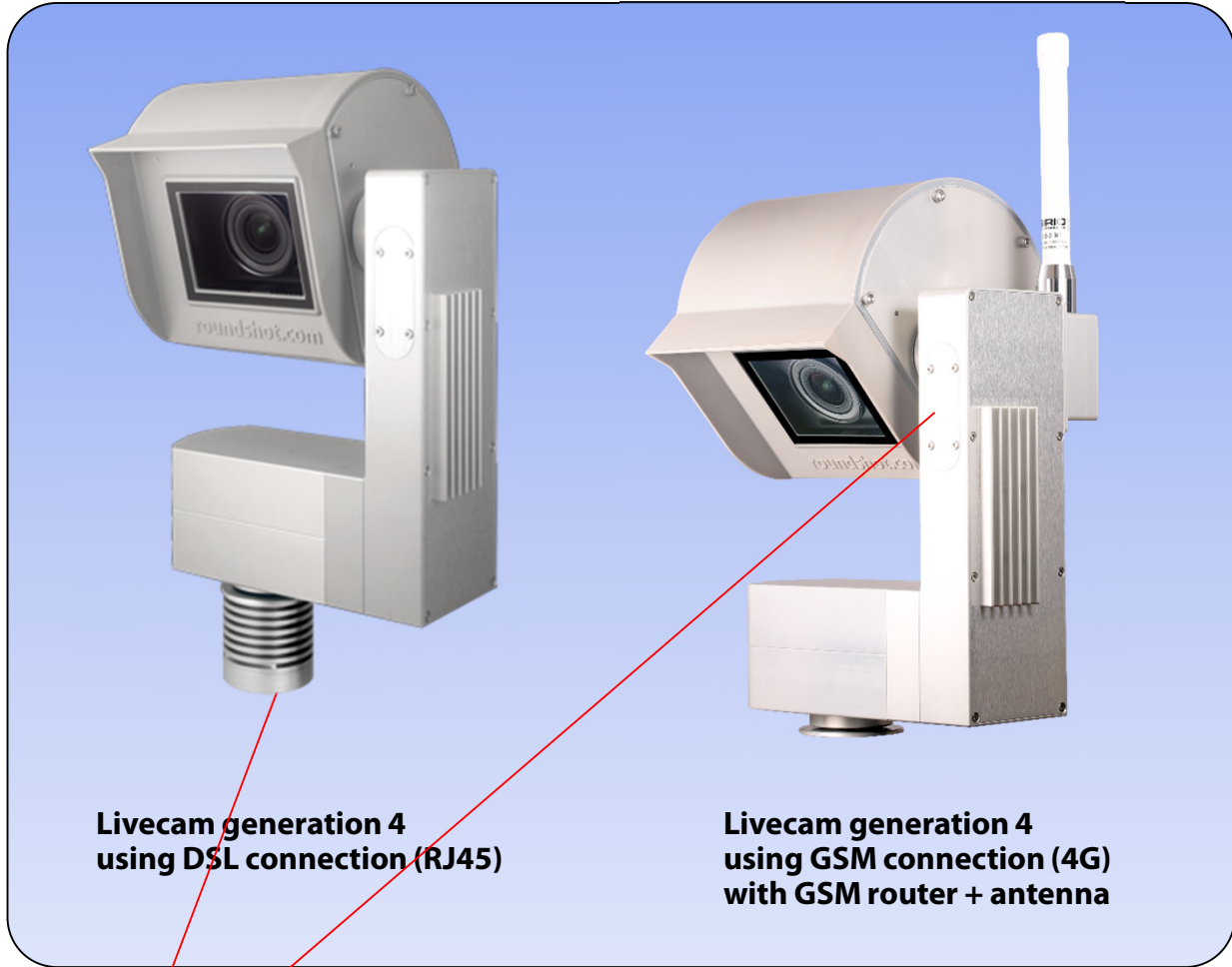

**Push button to set camera computer network IP to ...**



- DHCP**
- fixed IP (192.168.1.80)**
- slot for large SIM card**
- slot for SD card 128 GB**

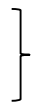

The currently applied setting is indicated with a permanent green LED.

## 2. Preparations prior to camera shipment

### 2.1 Site preparation

The customer is responsible for selecting the camera site and preparing for the installation of the camera. Proper site preparation includes:

- Selection of best **camera position** (ideally with 360° view)
- Installation of **camera mast**
- Selection of **connection type** (wired Ethernet, wifi or cellular 4G)
- Preparation of **network connection** requirements:
  - DHCP or fixed IP
  - Firewall settings as required
- Preparation of **power connection** 110V or 220V with protected location for mains adaptor (for example in waterproof box if installed outdoors)
- Installation of **power supply** and lightning/surge protection
- Installation of **power cable** - maximum length: 15m / 50 ft
- Installation of **Ethernet cable** (if wired) – maximum length: 100m (or longer if connecting through switch)



## 2.1.1. Installation of camera mast

### Mast types

Wall attachment with straight tube

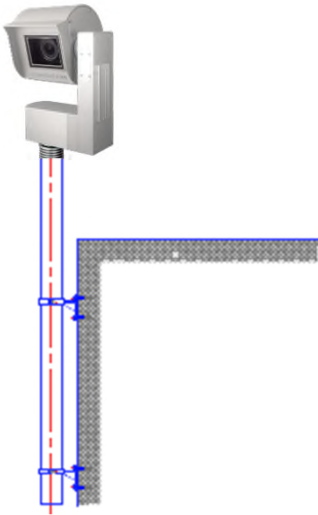

Wall attachment with curved tube

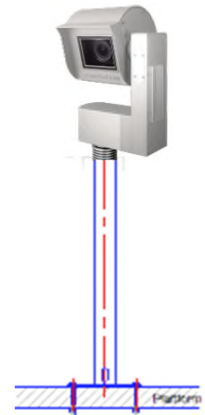
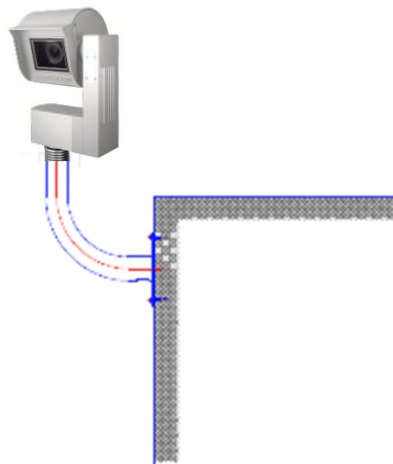

Stand-up tube for flat attachment on ground

Roof attachment  
(roof pass-through)

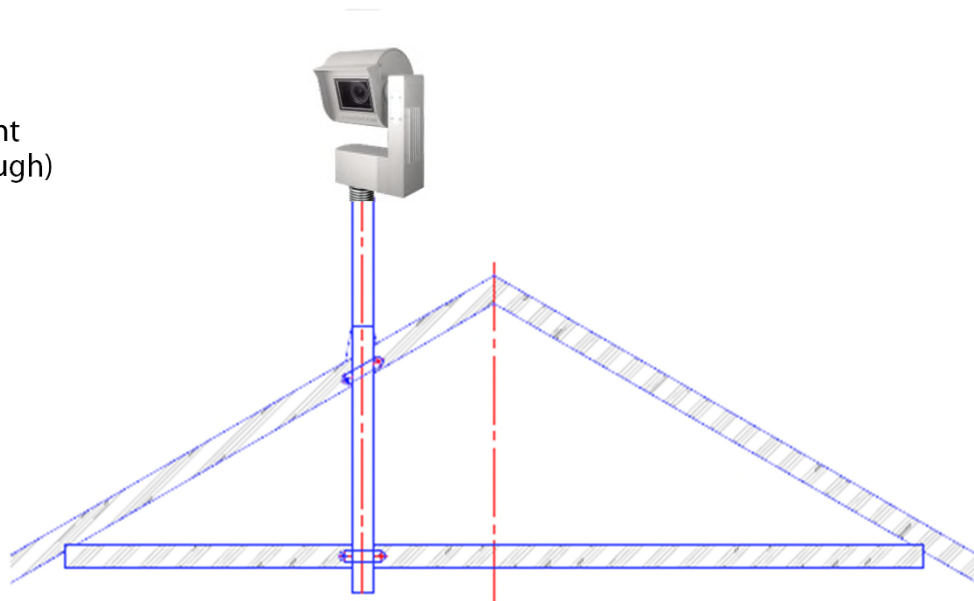

**Very important:** The mast must be grounded.

## 2.1.1. Installation of camera mast (continued)

### Camera dimensions

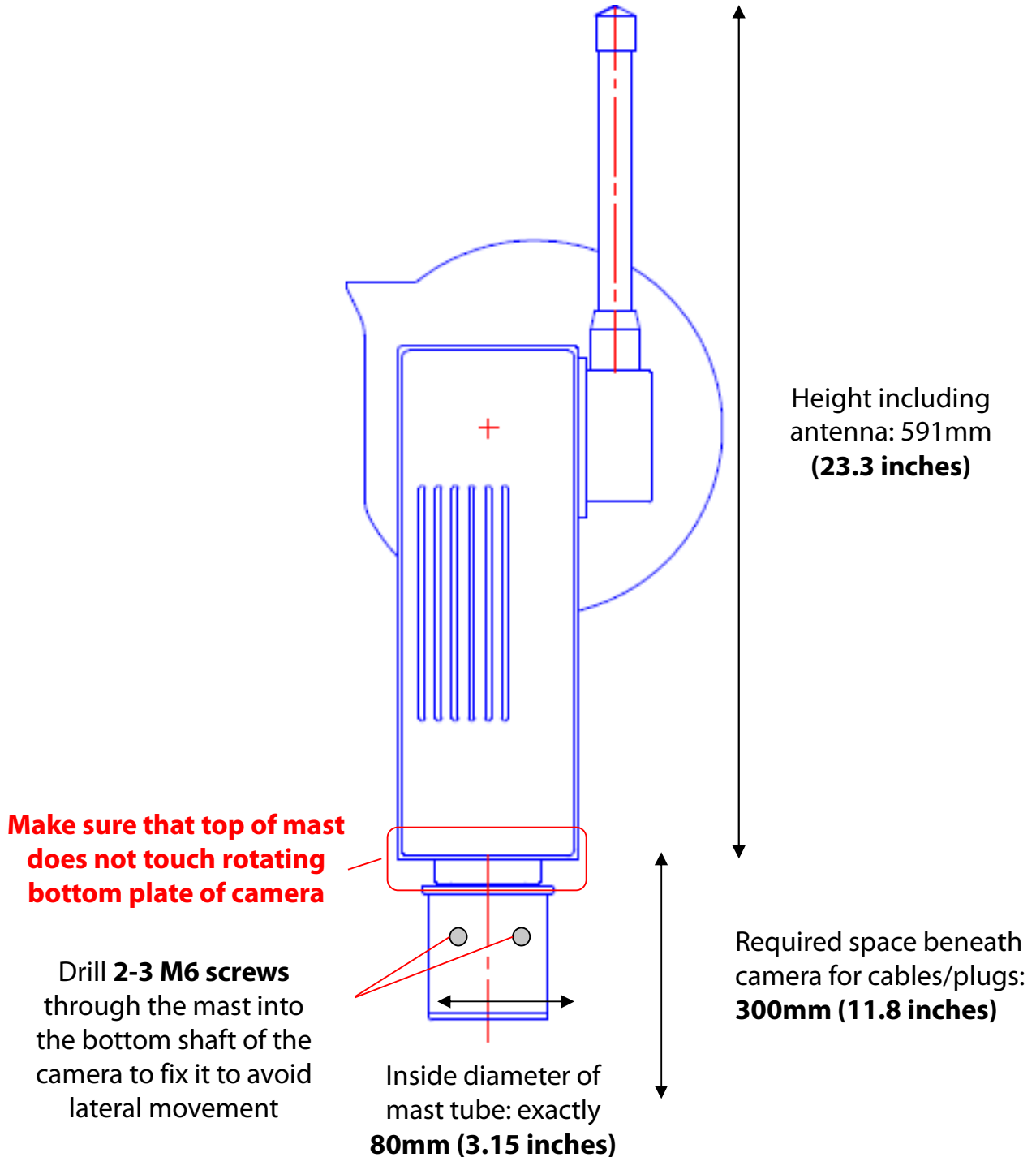



## 2.1.1. Installation of camera mast (continued)

### Camera dimensions

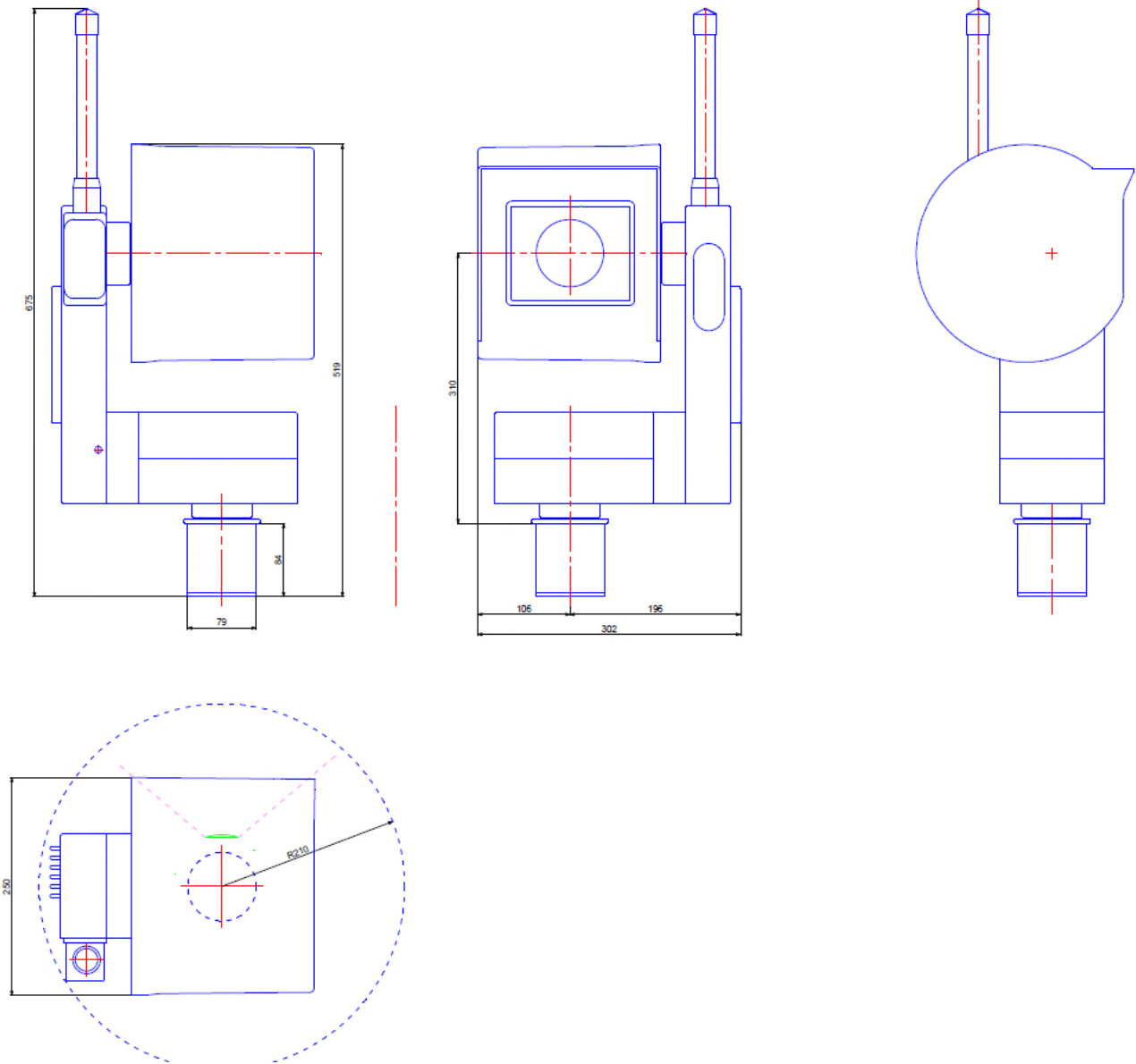

## 2.1.1. Installation of camera mast (continued)

Correct mounting

Incorrect mounting  
(camera motor sits on mast  
inner dimensions of mast > 80 mm)

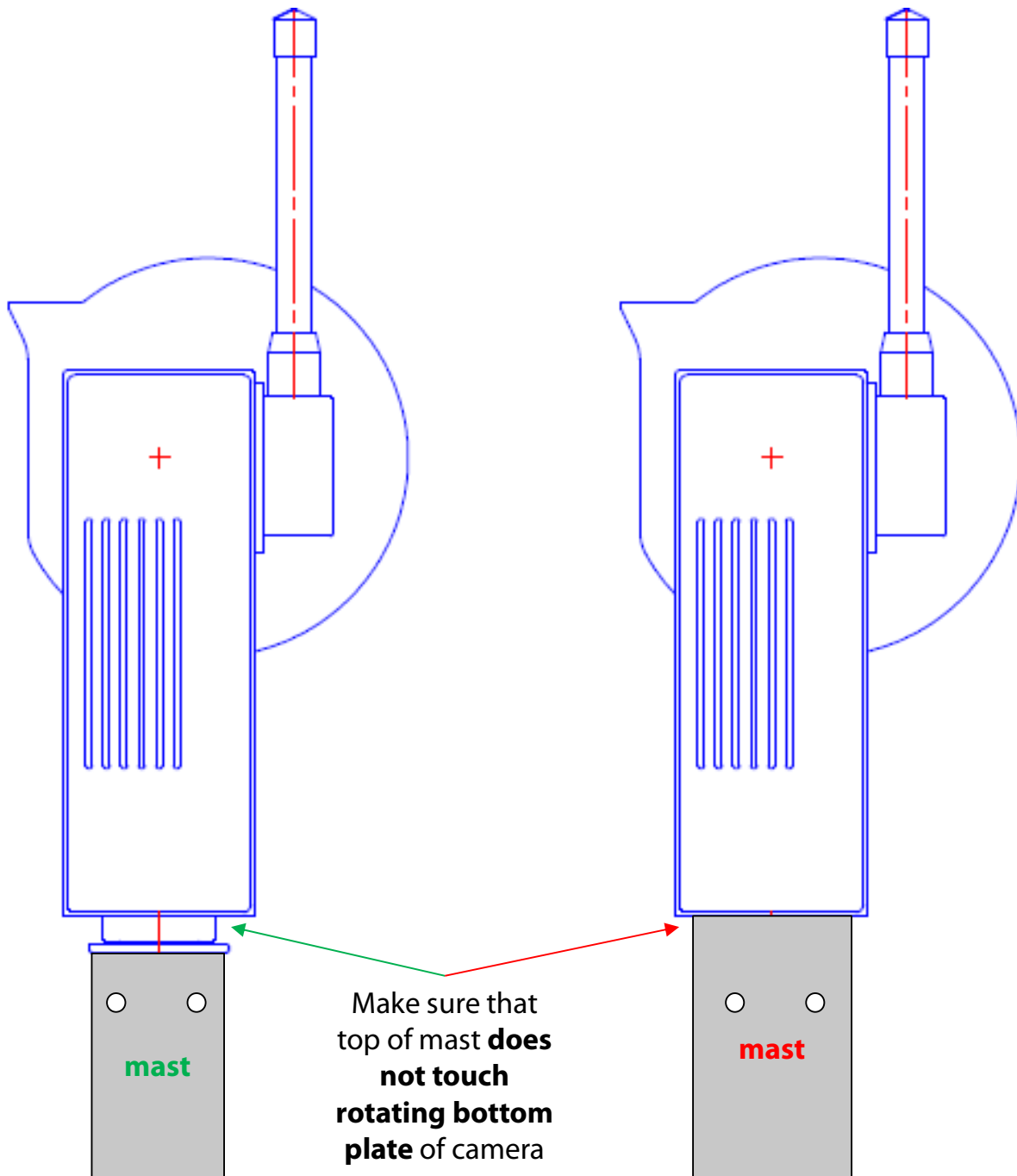

## 2.1.1. Installation of camera mast (continued)

### Camera cable connectors – ferrite elements



**The ferrite elements are installed on the cable strands close to the camera.** Installing them on the opposite side of the cable is possible but will be less beneficial for the camera.



Ferrite beads are used in electronic circuits to suppress interference, noise, crosstalk, and other high-frequency disturbances from supply voltage lines, data signal lines, and ground planes.

## 2.1.2. Network connection – example DSL / wired

### Power cable

Pin 2 = +24 V  
Pin 3 = -



Mains adaptor  
110-220V / 24V



### Ethernet cable (RJ45)

IP:

- DHCP or
- fixe IP

T-568B

1 2 3 4 5 6 7 8

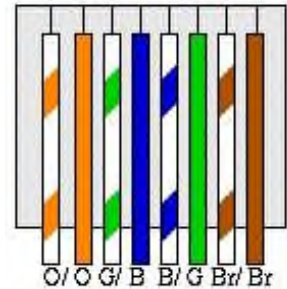

Max = 15m

Max = 100m

Lighting protection  
Power & RJ45  
(optional)

Switch

Internet access

Router / DSL



- Please provide the following network data to Roundshot prior to shipping:
  - IP through DHCP (automatically assigned by switch/router/network)
  - Fixed IP (IP, subnet mask + gateway + DNS1 + DNS2)

### 2.1.3. Network connection – example mobile network (4G)

#### Power cable

Pin 2 = +24V  
Pin 3 = -



Mains adaptor  
110-220V / 24V



Max = 15m

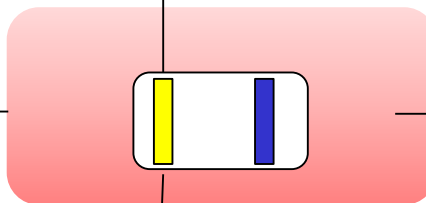

Lighting protection  
Power (optional)



mobile network (4G)

IP: DHCP



Internet access  
→  
Router / DSL



Please confirm to Roundshot prior to shipping that the camera will be connected through wifi or through 4G.

## 2.1.4. Power connection – mains adaptor

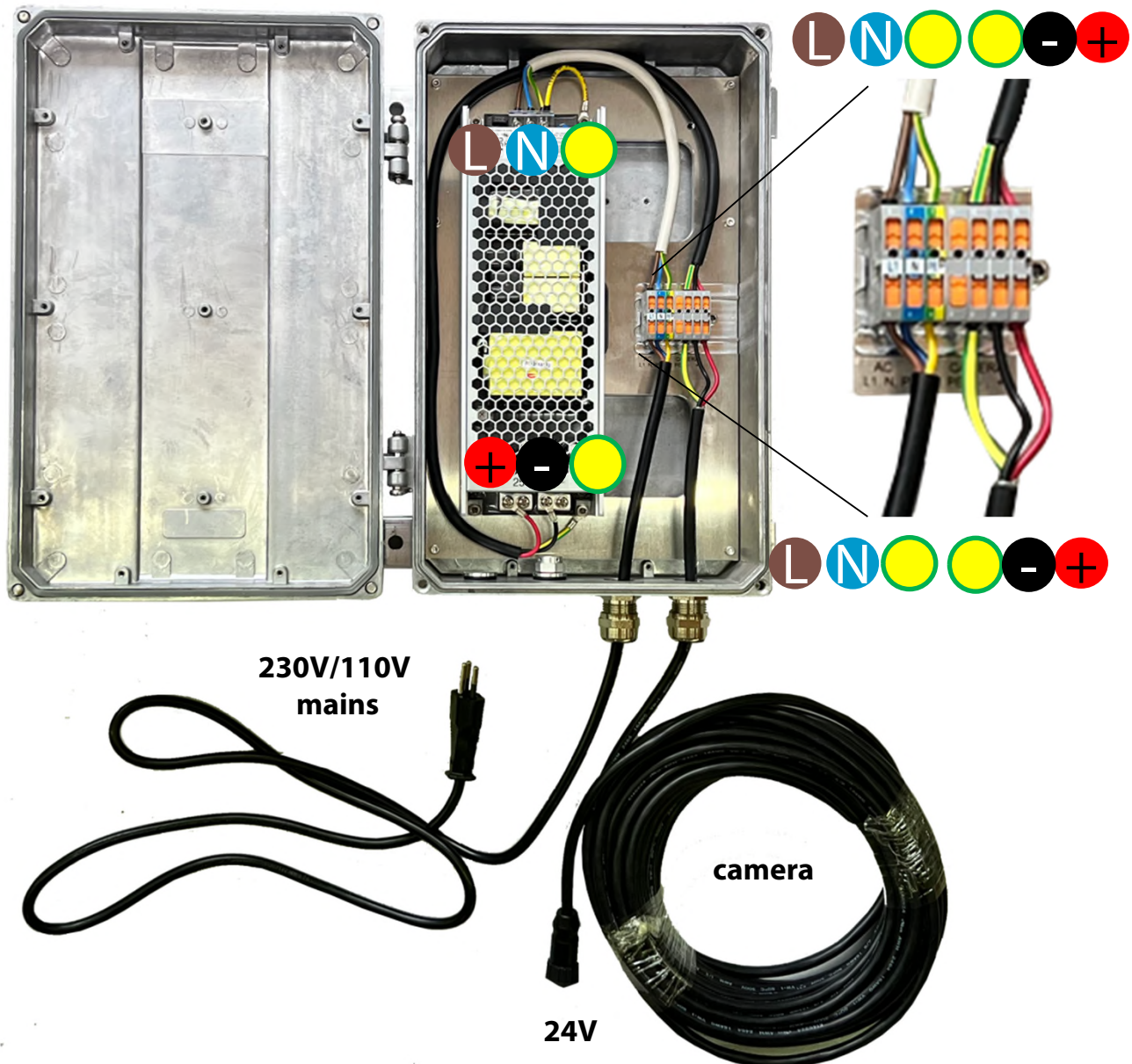

**Very important:** The mains adaptor casing must be connected by cable (yellow/green) to the ground.

## 2.1.5 Attaching the mains adaptor with metallic box on a mast

### Pole installation

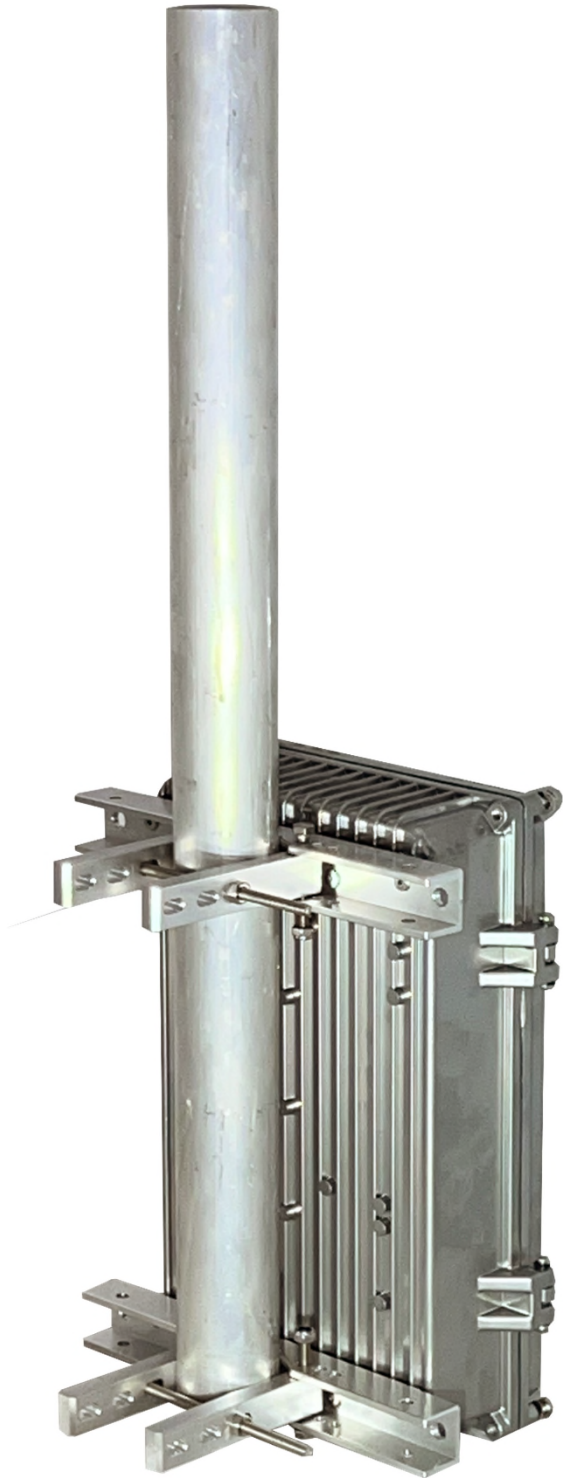

## 2.1.5 Attaching the mains adaptor with metallic box on a mast (continued)

### Mast installation (outside diameter 90mm)

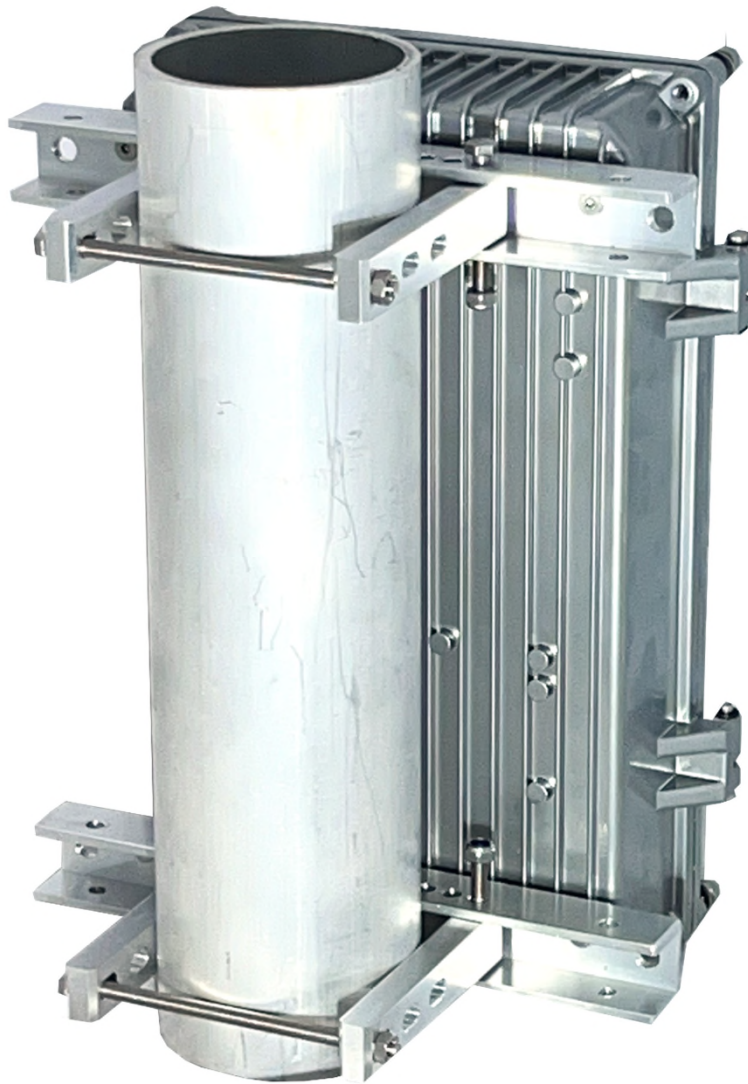



## 2.1.5 Attaching the mains adaptor with metallic box on a mast (continued)

### Installation on larger structure (for example tower)



## 2.1.6. Lightning protection (optional)

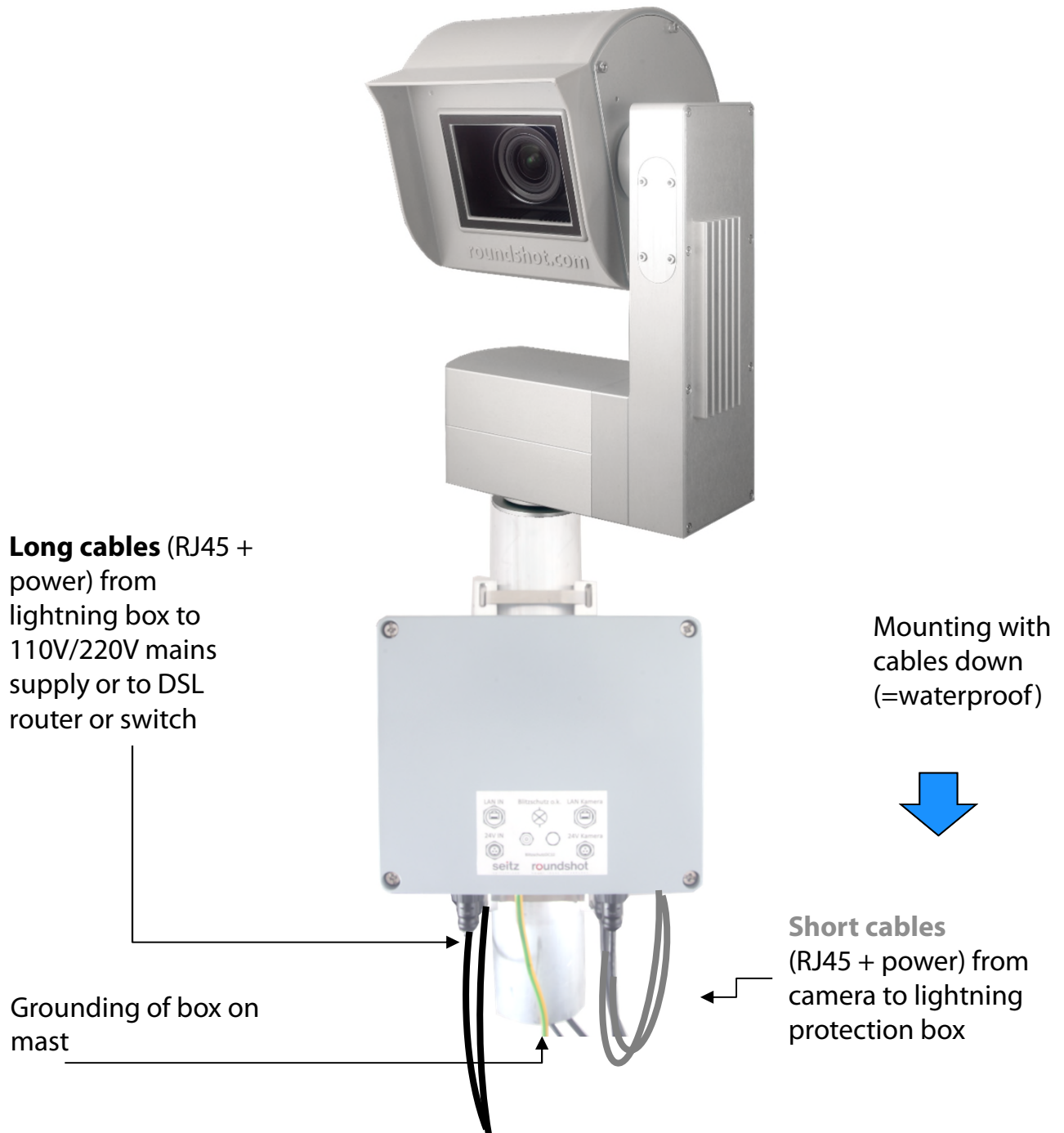

- The optional lightning protection is installed closely beneath the camera on the mast
- It protects the camera from being damaged by lightning (overcharge) induced by the cables into the camera housing
- An opening of about 5cm diameter (2 inches) needs to be drilled into the mast to pass the cables to the lightning protection box through the mast

## 2.1.6. Lightning protection (optional) – (continued)

**Box open:**

Grounding cable to cover

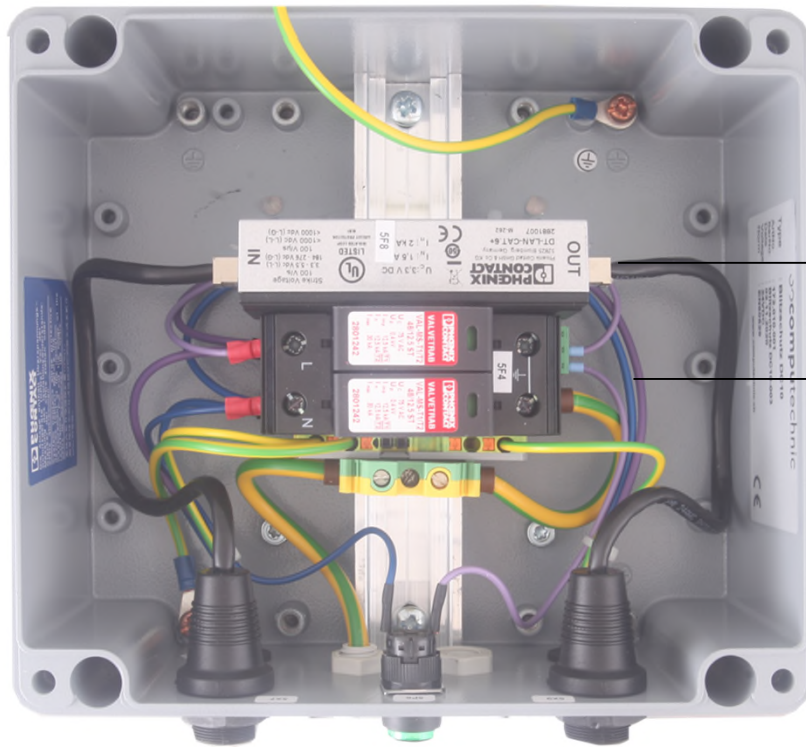

Lightning protection RJ45

Lightning protection power (L + N)

**Box from below**

Power-LED "OK"

RJ45 cable long (to DSL router/switch)

Power cable long (to mains adaptor)

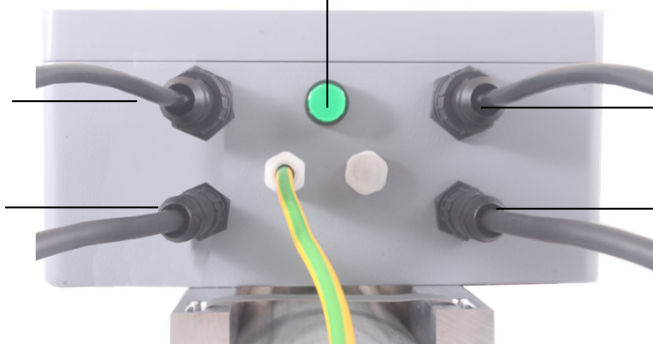

RJ45 short (to camera)

Power cable short (to camera)

Erdungs-Kabel (zum Masten)



When installing the box there is no need to open it – just attach it on the mast and connect the cables



**Very important:** The mast needs to be grounded.

# 3. Camera installation

## 3.1 Network connection with DSL / wired

Please **test the network connection in the office before installing** the Livecam on the mast. This avoids lengthy installations/deinstallations.

Before shipping the Roundshot team will prepare the network card of the Livecam computer according to customer instructions:

- **DHCP** (to assign automatically by switch/router/network (standard case for private or small networks)
- **Fixed IP** (for larger networks where IPs are assigned by network administrator)

In this case the Livecam should connect to internet automatically once installed.

Please allow 5-10 minutes for the camera to power up, calibrate itself and obtain the IP or register in the network. Once the internet connection is established, the Livecam will automatically log in at the Roundshot VPN server and the Roundshot staff can connect to the camera.

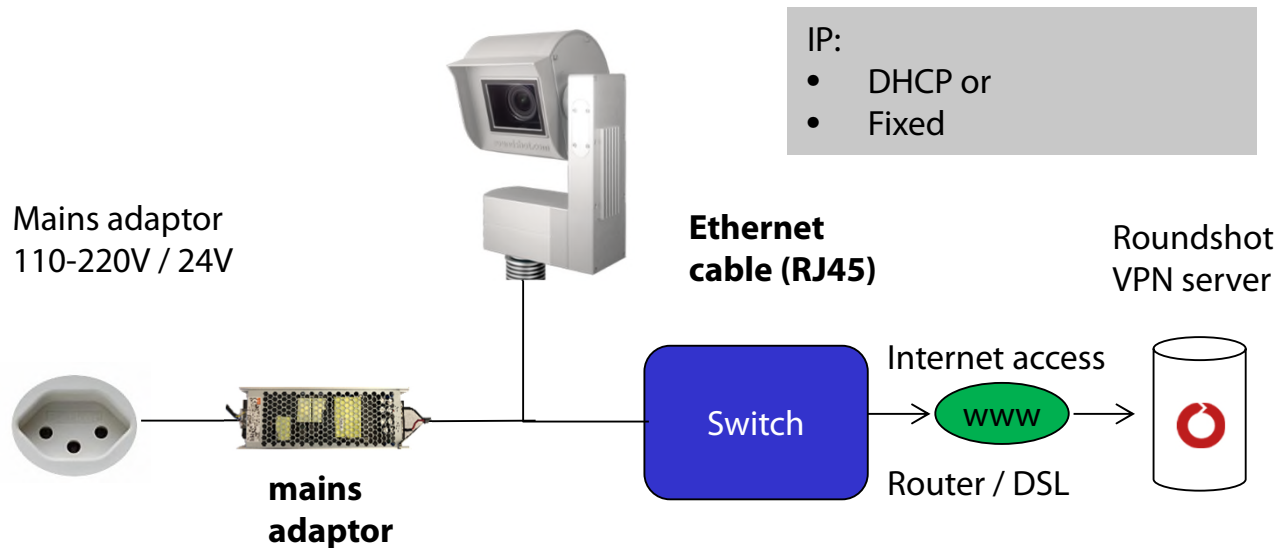

Contact the Roundshot team who will check if the connection to the VPN (remote access to camera) has been successfully established.



If yes, we will now connect to the camera to configure it for service.

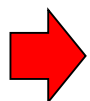

If no, please go to section «problem solving» to establish the connection.

### 3.1 Network connection with DSL / wired (continued)

To connect to the Livecam, the first step is to **determine the IP that is currently used by the camera computer**.

- If the Livecam will use a **fixed IP**, this fixed IP has already been sent to roundshot and set in the network configuration of the computer, so you will be able to use that IP.
- If the Livecam is obtaining its **IP automatically** through **DHCP**, there are two ways to obtain its IP:
  - a. By having the camera powered up and connected by RJ45 cable within the network and using an IP scanner software (such as Angry IP Scanner: <https://angryip.org/download>)
  - b. By resetting the camera computer to a fixed IP (192.168.1.80) using a hardware reset button -> see chapter 3.3 Network connection trouble-shooting
- If all of the above fails, it is also possible to use the **Livecam serial number** to connect: **roundshot\_#####** where the last 12 digits represent the computer mac address. This serial number can be found:
  - on the camera front panel (above lens)
  - on the Livecam invoice
  - by scanning the network for new IPs / mac addresses
  - by contacting roundshot

Bring your **computer network configuration** into the same range as follows – for example:

computer IP: 192.168.1.70  
subnet mask: 255.255.255.0  
gateway 192.168.1.1

camera: 192.168.1.80

Download VNC Viewer (RealVNC, not Ultra VNC) and connect to the camera computer:

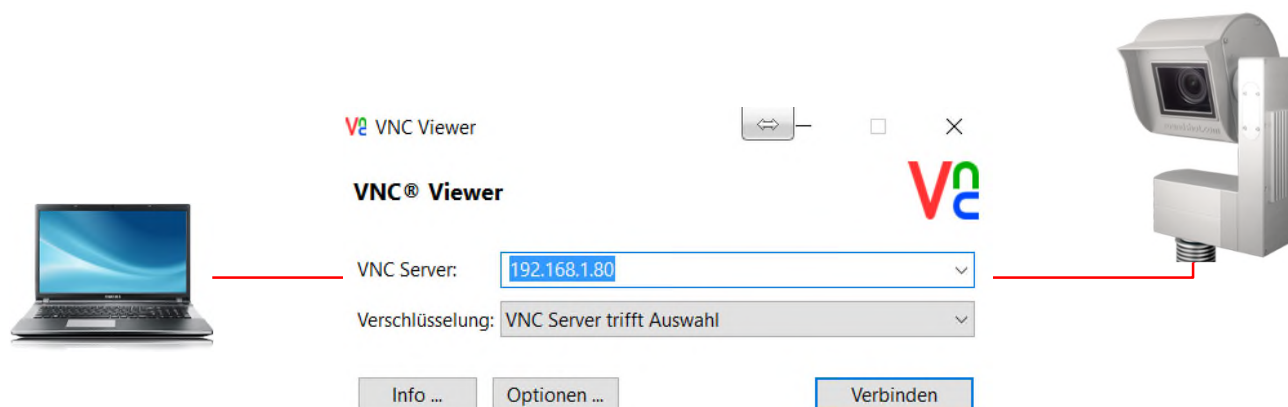

### 3.1 Network connection with DSL / wired (continued)

User: livecam

Only the **password** needs to be entered.

Password: **livecamG3**



Factory **default password** (without upload password)

Password: \*\*\*\*\*



Equal to **upload password** if the upload credentials have already been prepared prior to shipping

This opens a connection to the Livecam computer :



An alternate method is to connect by using the computer mac address / serial number of the camera (roundshot\_#####):

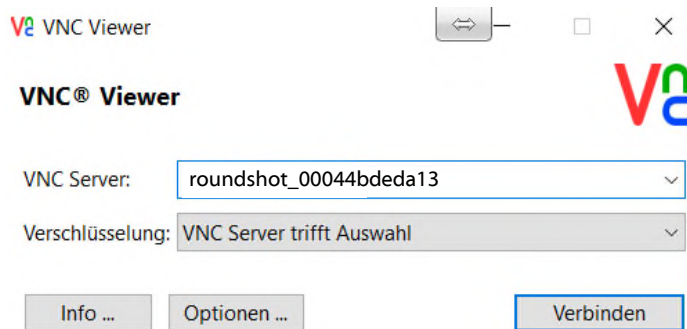

Once the Uploader is activated with an **upload password**, it will automatically be set as **access password** to the camera.



If the upload configuration of the Livecam has already been prepared by roundshot prior to shipping, please contact roundshot to obtain this password.

### 3.1 Network connection with DSL / wired (continued)

Now open up the **edit connections menu** with a left-mouse click on the two arrows up/down ( ↑↓ ) next to the clock on the upper-right corner of the screen:

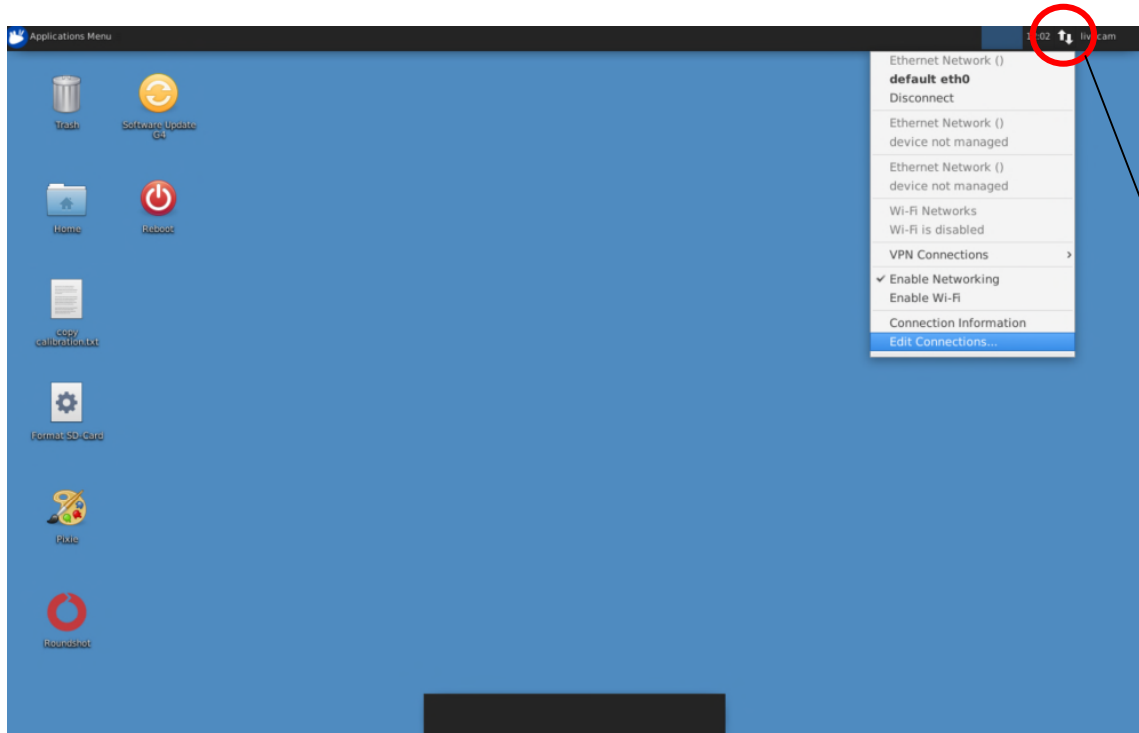

left  
mouse-  
click

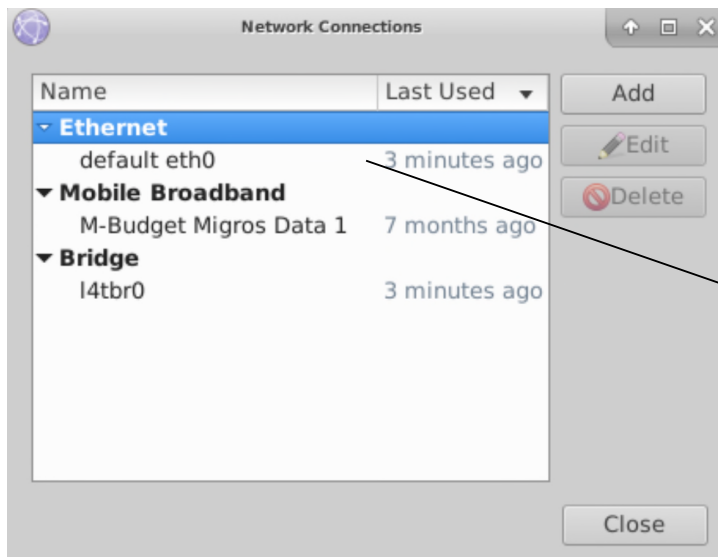

Click on first ethernet  
connection (default  
eth0) + Edit

### 3.1 Network connection with DSL / wired (continued)

Click on the IPv4 Settings tab and select the preferred **method**:

- Manual (fixed IP)
- DHCP (automatic IP)

When choosing “Manual” please enter the **complete network parameters** including IP (address), subnet mask (Netmask), gateway + DNS + Search Domains, for example:

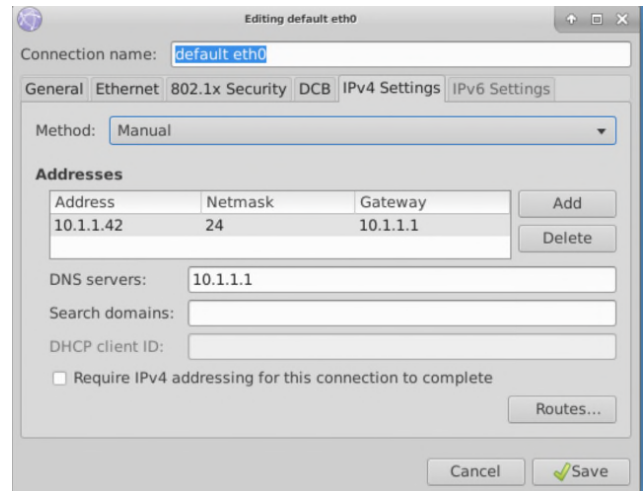
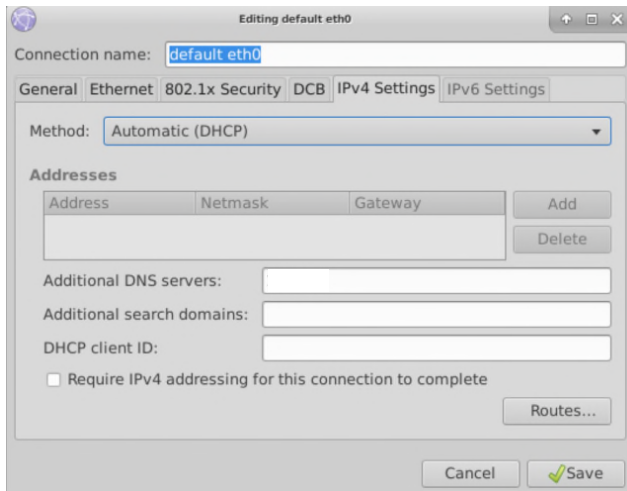

When entering the subnet mask (Netmask), the values will be indicated in binary power format, for example:

$$255.255.255.0 = 24$$

where 255 represents 256 digits (0..255) and is denoted  $2^8$   
and  $255.255.255.0 = 2^8 * 2^8 * 2^8 = 2^{24}$

Press **“Save”** and **“Close”** to return to the desktop.



### 3.2 Network connection with GSM network (4G)

Please **test the network connection in the office before installing** the Livecam on the mast. This avoids lengthy installations/deinstallations.

For Livecams that connect to the network by wifi or by mobile network a **special module** needs to be installed in the camera computer. Please make sure to specify this requirement when ordering the camera.

In this case, **the Roundshot team will set the IP for the camera computer to DHCP and preconfigure the APN settings of your data plan provider.**

If it is necessary to reconfigure the APN settings, please set the IP to fixed (192.168.1.80, see page 4 for instructions) and connect as follows:

Connect a laptop or other computer directly to the camera:



Ethernet patch (RJ45) cable



Set the IP of your computer (ethernet card) within the same range and subnet as the camera, for example:

IP-Adresse automatisch beziehen

Folgende IP-Adresse verwenden:

IP-Adresse:

Subnetzmaske:

Standardgateway:

DNS-Serveradresse automatisch beziehen

Folgende DNS-Serveradressen verwenden:

Bevorzugter DNS-Server:

Alternativer DNS-Server:

### 3.2 Network connection with GSM network (4G) – (continued)

Download and install a **VNC software** to establish the connection, for example VNC Viewer. Enter the fixed IP of the camera to connect:

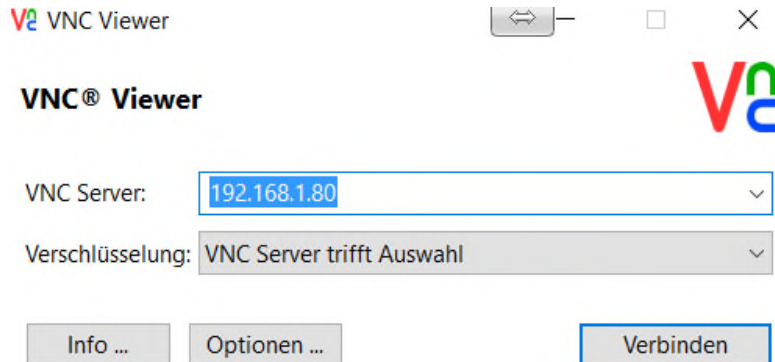

User: livecam

Only the **password** needs to be entered.

Password: **livecamG3**



Factory **default password** (without upload password)

Password: \*\*\*\*\*



Equal to **upload password** if the Livecam has already been prepared with upload credentials prior to shipping

This opens a connection to the Livecam computer with Linux operating system:



Once the Uploader is activated with an **upload password**, it will automatically be set as **access password** to the camera.



If the upload configuration of the Livecam has already been prepared by roundshot prior to shipping, please contact roundshot to obtain this password.

### 3.2 Network connection with GSM network (4G) – (continued)



Insert a large mobile network SIM card into the slot.

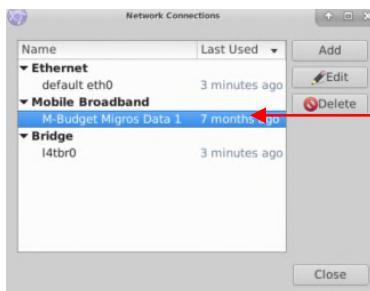

Open up the **edit connections menu** and make a left mouse-click on the mobile broadband connection and press "Edit".

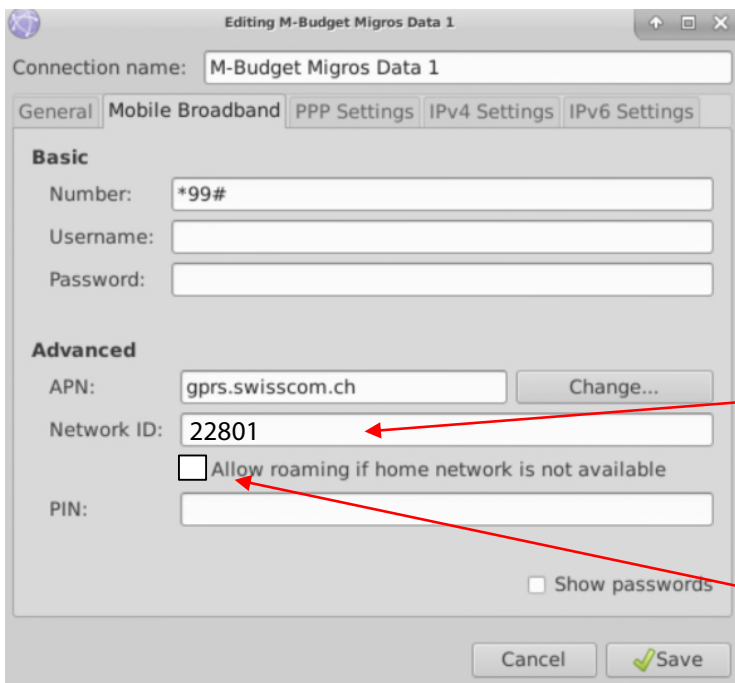

Enter the **Network ID** of your provider to always lock the connection. This prevents potential roaming.

Make sure that the option «**Allow roaming if home network is not available**» is **not activated** (not ticked).

### 3.2 Network connection with GSM network (4G) – (continued)



Edit now the settings for this GSM Connection and enter the data according to the following table:

- Number
- Username
- Password
- APN
- Network ID

Provider	Country	Number	User name	Password	APN	Network ID
Swisscom	Switzerland	*99#			gprs.swisscom.ch	22801
Sunrise	Switzerland	*99#			internet	22802
Salt (Orange)	Switzerland	*99#			internet	22803
Digital Republic (Sunrise)	Switzerland	*99#			dr.m2m.ch	22802
Orange	France	*99#	orange	orange	orange.fr	20801
SFR	France	*99#			wapsfr / s12sfr	20810
TIM	Italy	*99#			ibox.tim.it	22201

Enter the **Network ID** of your provider to always lock the connection. This prevents potential roaming.

**Untick «Allow roaming»** to fix the connection to your provider.

**PIN:** The PIN code needs to be deactivated on the SIM card (for example by using the SIM in a mobile phone)

Confirm all settings by pressing **«save»**.



The APN settings of your GSM provider can be found by a google search, for example “APN settings orange france”.

### 3.2 Network connection with GSM network (4G) – (continued)



It is also possible to use the **Set-up Assistant** by clicking on **“Change”**:

The Set-up Assistant will guide you step-by-step through selecting the country, provider and billing plan to obtain the correct APN settings:

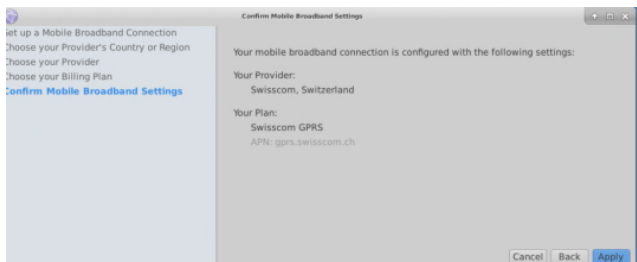
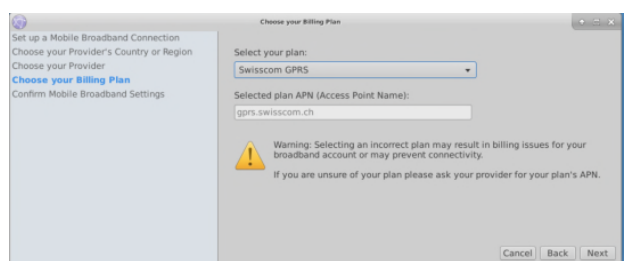
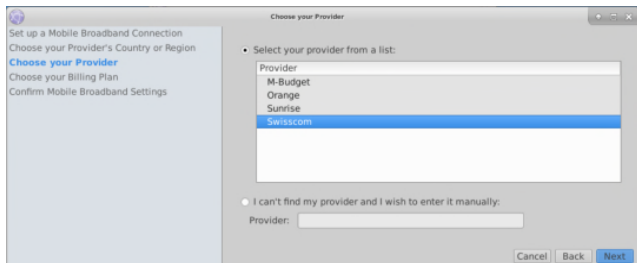
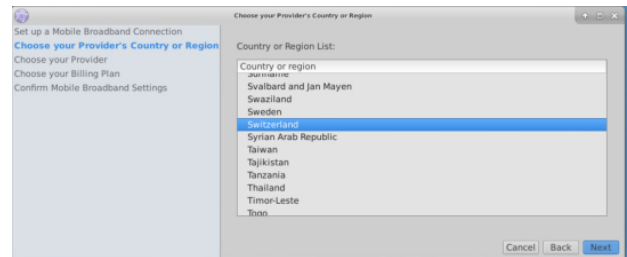
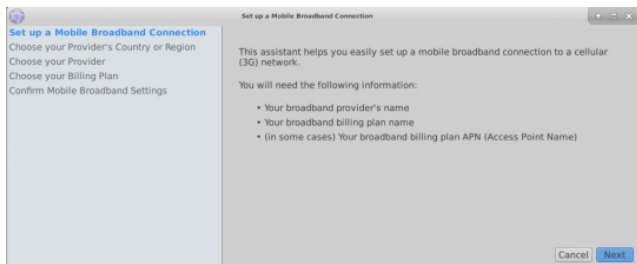

Confirm all settings by pressing **«apply»** and **“save”**.

### 3.2 Network connection with GSM network (4G) – (continued)

The camera is now connected to your GSM network. Unplug your ethernet cable.

After a reboot the camera will connect to the GSM network within 5-10 minutes.

Contact the Roundshot team who will check if the connection to the VPN (remote access to camera) has been successfully established.



If yes, go ahead with the installation of the camera on the mast. Once the camera is installed, the Roundshot team will now connect to the camera to configure it for service.

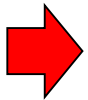

If no, please go to section «trouble-shooting» to establish the connection.

### 3.3 Network connection trouble-shooting

If the connection cannot be established please follow these steps:

1. Is the power cable with mains adaptor plugged-in and is the camera powered-up? If so, the fans turn which creates a distinctive noise (even with closed waterproof case).
2. Do you know the IP of your camera? The standard (factory) IP is 192.168.1.80.
3. Have you set **the correct IP** on your computer? The computer IP needs to be different from the camera IP but in the same range, for example:

```
camera: 192.168.1.80  
  
computer IP: 192.168.1.70  
subnet mask: 255.255.255.0  
gateway: 192.168.1.1
```

4. If all fails, please **reset the camera IP** either to a fixed (factory) IP or to DHCP:

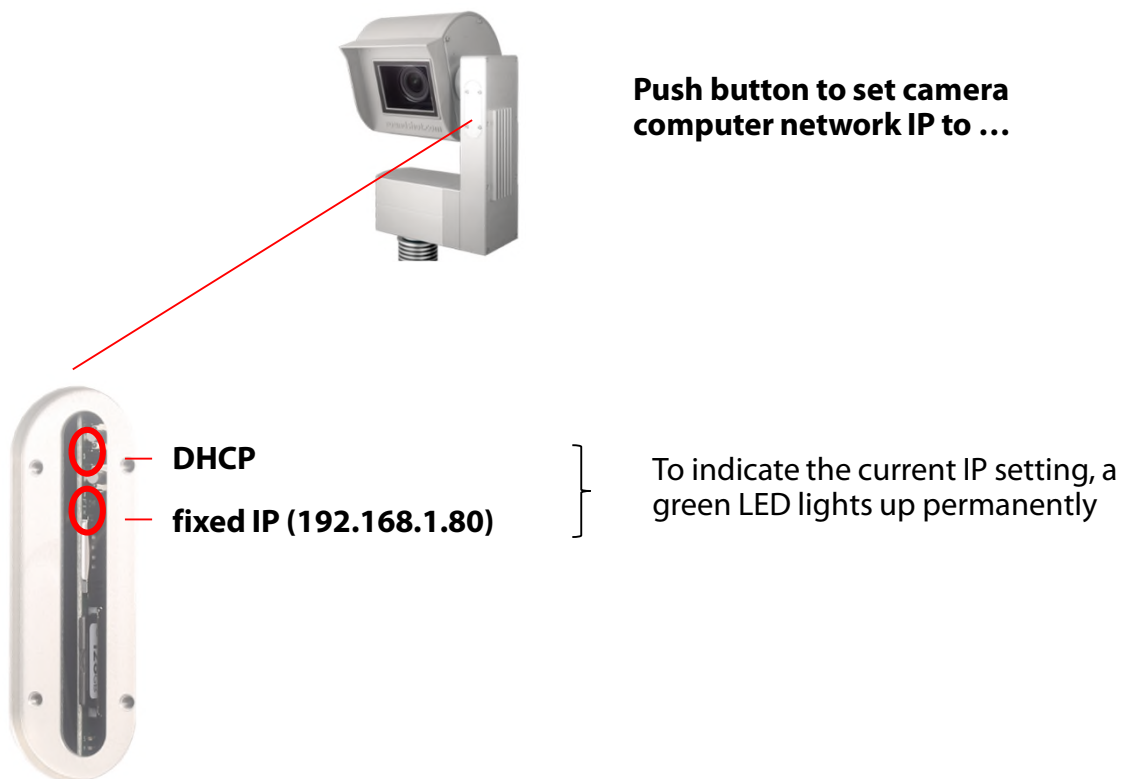

Reboot the computer by turning the power off/on.  
Wait approximately 5 minutes for the camera to reinitialise.  
It may be necessary to repeat this procedure.

### 3.4 Firewall settings

The following ports need to be opened on the firewall to allow communication between Livecam and external servers:

Port	Remarks
80	VPN connections – binary packets may not be blocked
443	Uploader (https)
123	Time synchronisation with time servers

### 3.5 Network security

For security reasons the Linux computer does not contain any DNS server. All internet connections are established between camera and a set of predefined IPs + URLs:

- backend.roundshot.com
- endpoint.roundshot.com
- vpn.roundshot.com
- ntp.metas.ch
- time.c.nist.gov
- time.nrc.ca
- ntp.nml.cfiro.au
- time.stdtime.gov.tw



## 4. CE Conformity Declaration



Seitz Phototechnik AG  
Frauenfelderstrasse 26  
8512 Lustdorf / Switzerland  
ph: +41 52 369 68 00  
info@roundshot.com www.roundshot.com



We declare under our own responsibility that our product

### Livecam Generation 4

is compliant with the main requirements of machinery directive 2006/42/EG.

The following standards have been applied:

Model/Type reference:	Roundshot Livecam G4	Serial no:	00:04:4B:DE:DA:E0
Trade mark:	Seitz Phototechnik AG	Date of tests:	2020-01-16 until 2020-02-11

Standards		Result
EN 55032:2015 CISPR 32:2015	Electromagnetic compatibility of multimedia equipment - Emission requirements	Pass
EN 55035:2017 CISPR 35:2016	Electromagnetic compatibility of multimedia equipment - Immunity requirements	Pass
EN IEC 61000-6-2:2019 IEC 61000-6-2:2016	Electromagnetic compatibility (EMC) – Part 6-2: Generic standards - Immunity for industrial environments	Pass
EN 61000-6-3:2007 +A1:2011 + AC:2012 IEC 61000-6-3:2006 /AMD1:2010	Electromagnetic compatibility (EMC) – Part 6-3: Generic standards - Emission standard for residential, commercial and light-industrial environments	Pass

Date and location:

Lustdorf / Switzerland, 8 May 2020

Seitz Phototechnik AG

Peter Seitz

Werner Seitz

Attachment:

Eurofins test report

# Impressum



## Copyright 2024 by

Seitz Phototechnik AG  
Frauenfelderstrasse 26  
8512 Lustdorf / Switzerland

ph: +41 52 369 68 00  
email: [info@roundshot.com](mailto:info@roundshot.com)

[www.roundshot.com](http://www.roundshot.com)

Technical changes reserved  
April 2024

